Poly Skiver PS-083

Operation Manual



- Follow this manual when using Poly Skiver.
- Please pass this manual to Poly Skiver users for a safe and trouble-free operation.
- Keep this manual carefully in an easy-to-access location for future reference.

NITTA CORPORATION

Contents

1. Safety Precautions	2
2. Confirmation of Product	6
3. Specifications	7
4. Use Environment	8
5. Storage Environment	8
6. Name of Parts	9
7. Preparation	10
8. How to use	11
9. Maintenance	15
10. Troubleshooting	18
11. Inspection	19
12. Warranty and after-sales service	20

1. Safety Precautions

Read through these safety precautions carefully before using the Poly Skiver PS-083 for securing a correct and safe operation.

 **WARNING** Disregarding instructions marked with this symbol may lead to death or a serious injury.

 **CAUTION** Disregarding instructions marked with this symbol may lead to a minor injury or property damage.

 **WARNING**

 **WARNING** ● **Do not use the Skiver for any application other than the intended purpose of grinding belt joints.**

Use for any unintended purpose may cause an unexpected accident.
Improper use may cause a fire, an electric shock or an injury.

 **WARNING** ● **The Skiver is not intended for using singly by physically or mentally challenged individuals.**

They must use the Skiver only under the supervision of the person responsible for the entire work.
Otherwise, a fire, an electric shock or an injury may occur.

 **WARNING** ● **Do not allow the child to handle the Skiver.**
Keep the Skiver out of the reach of children.

Otherwise, a fire, an electric shock or an injury may occur.

 **WARNING** ● **Never disassemble or modify the Skiver.**

Otherwise, a fire or an electric shock may occur.
For repair or maintenance, contact your local distributor or agent in your area.

 **WARNING** ● **In the event of an emergency such as smoke, a fire, smells, unplug immediately and contact Nitta, your local distributor, or agent in your area for maintenance.**

Otherwise, a fire or an electric shock may occur.

 **WARNING** ● **Prior to use the Skiver, fix it on the stand with sufficient strength and stability to load it using the supplied brackets and bolts.**

Tipping over of the Skiver may result in a serious injury.



- **Check to ensure that the power source used is within the specified range shown below.**

Using the Skiver with a wrong power source may cause a failure, a fire or an electric shock.

100V/50 Hz	100V/60 Hz	110V/60 Hz
5.8 A	5.0 A	5.2 A



- **Do not use the Skiver under the following conditions.**

Otherwise, a fire or an electric shock may occur.

- Under flammable or ignitable gas environment
- Under corrosive gas environment
- Under the environment temperature below 5°C
- Under the environment temperature over 30°C
- Under the high humidity environment over 85%
- Under the environment exposing the Skiver to steam or water splash



- **Plug the cord correctly.**

The power cable of the Skiver has a grounding plug.

Plug the cord correctly into the grounded outlet.

Otherwise, you may receive an electric shock.



- **Use a conversion plug when the shape of the power cable differs from the outlet shape.** Using the wrong plug may cause an electric shock.

The plug shape of the supplied power cable is as shown below. The conversion plug is not supplied. If necessary, prepare the suitable conversion plug by customer's self.

Specification	Plug type	Plug illustration
For 100 V	A Type	



- **Impressed voltage is energized through the power cable as it is. Exercise care to avoid damaging the cable.**

Otherwise, a fire or an electric shock may occur.

- Hold the power plug with your hand and unplug.
- Do not modify or replace the power plug.
- Do not place any object on the power cable.
- Do not fold the power cable.
- Do not yank the power cable.



- **Use an extension cable for 3-conductor grounding plug.**

When you must use an extension cable, use an extension cable equipped with grounding plug. Otherwise, you may receive an electric shock.



- **Never operate the Skiver with wet hands.**

Otherwise, you may receive an electric shock.



- **Do not wet or splash water over the Skiver.**

Using the wet Skiver may cause a fire or an electric shock.



- **Unplug immediately after use. The operator must pay attention so that others do not touch the Skiver carelessly.**

Otherwise, others may get burned and injured.



- **Use a dry cloth for cleaning the Skiver.**

Do not use alcohol, benzene, thinner or any other inflammable solvent.

Otherwise a fire could occur.



- **The Skiver grinding part of the grinding roll rotating at high speed is exposed. Never touch the grinding roll during operation.**

You may be caught in the grinding roll and get a serious injury.



- **Grind the belt at several times, and move the grinding table slowly. The appropriate thickness to grind at a time is 2 mm or less.**

Forceful grinding prevents the accurate processing of joints as well as heats up the grinding roll and peels the sandpaper, causing Skiver failure and an injury.



- **When grinding the belt with a thickness over 3 mm, measure the temperature of the grinding roll every one grinding process to prevent the temperature of the grinding roll from reaching 80 degrees Celsius or higher. (Prepare a contactless thermometer.)**

Otherwise, the grinding roll heats up and the sandpaper peels off, causing Skiver failure and an injury.



- **Never touch the grinding roll immediately after grinding processing. Extreme heat can result in burn injuries.**



- **When using the Skiver, wear safety goggles to protect eyes from dispersion of mine dust and the abrasive particles.**

When grinding in a very dusty place, also wear the mask.



- **Avoid wearing gloves when operating the Skiver.**
Otherwise, the gloves may be caught in the rotor, and you may be caught in the grinding roll and get a serious injury.



- **Make sure to use the Skiver with the cover attached.**
Otherwise, you may be caught in the driving belt and get injured.
You may also touch the live part and get an electric shock.



- **Do not grind with unnatural posture.**
Always stand securely and keep the balance while grinding.
Otherwise, you may be caught in the grinding roll and get a serious injury.

CAUTION



- **Do not use the Skiver outdoors.**
The Skiver is not designed for outdoor use.



- **Before using the Skiver be sure to inspect the Skiver in accordance with the procedure described on page 19.**
This may cause a fire or an electric shock.



- **Use the Skiver only for NittaPolyBelt endless.**
Using the Skiver for the belt of other manufacturer may result in imperfect endless and prevents the belt from functioning sufficiently.



- **Replace the sandpaper often.**
Poor grindability of the sandpaper impairs the processing accuracy of the belt.
Use the Skiver with fine grindability. Otherwise, the Skiver may be excessively loaded, resulting in failure.



- **When the grindability of the grinding roll gets worse, replace the sandpaper with a new one.**
Refer to page 17 in this manual for the replacement procedure.



- **Use only the sandpaper specified by Nitta.**
Using the sandpaper not specified by Nitta impairs the processing accuracy of the belt.



- **The Skiver is not equipped with dust collecting function.**
Clean the Skiver each time after use to keep it clean.

2. Confirmation of Product

Thank you for choosing our Poly Skiver PS-083.



- Check that the product is exactly what you have ordered.

Using the wrong product may cause a fire, an electric shock or an injury.

2-1) Confirmation of Product

Check the followings upon receiving the Skiver.

Contact Nitta or your local distributor or agent in your area for service if you find any deficiency or defect in your item.

- [1] Does the name plate show the items as ordered?
Check the model type.
- [2] Any damage during transportation?
- [3] Are screws and nuts tightly fastened?

2-2) How to Read Name Plate

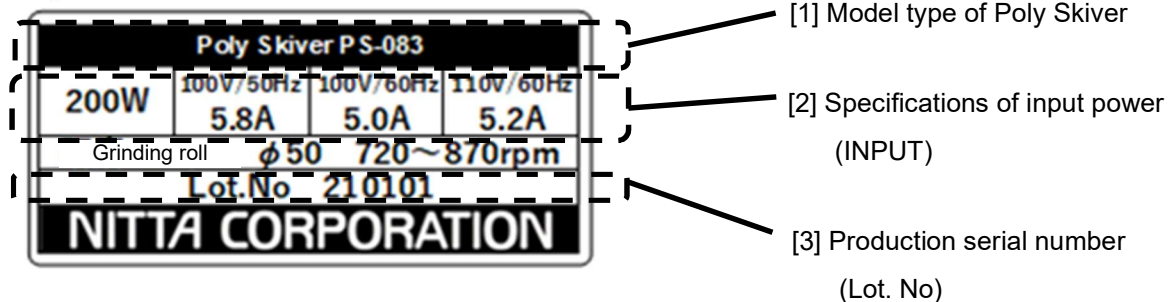

2-3) For inquiries

For inquiries, inform us of the model type and the production serial number

2-4) Accessories

Operation manual, PET film 1 sheet, Spare sandpaper 1 sheet

Off-center housing adjustment tool

3. Specifications

3-1) Outline of Poly Skiver

[1] Poly Skiver is designed to grind belts for Skiver joint processing. The Skiver has the table that enables accurate and diagonal grinding of the electric motor and a belt edge for driving grinding roll.

[2] Poly Skiver is compatible with the following belt specifications:

Belt type : NITTA Poly belt
Maximum belt width : *80 mm or less *Right-angle joint
Maximum belt thickness : 6 mm or less

3-2) Major Specifications of Poly Skiver

Model type	PS-083
Specification	100 V specification
Power source	Single phase 100 V to 110 V
	50/60 Hz
	200 W
Grinding roll	φ50, 720 to 870 rpm, stuck with sandpaper #80
Outer dimension	400 mm (W) × 330 mm (L) × 435 mm (H)
Weight	26 kg



- **The Skiver is a tabletop type. Before using the Skiver, fix it on a steady bench with the supplied brackets.**



- **The Skiver is heavy. Extreme care should be taken when handing it.**

4. Use Environment

Ambient Temperature	5 to 30°C (no condensation)
Ambient Humidity	15 to 85% RH
Place of Use	Indoors (free from dust, water)
Environment No	No flammable, ignitable or corrosive gas, no steam



- **Do not use the Skiver under the following conditions.**

Otherwise, a fire or an electric shock may occur.

- Under flammable or ignitable gas environment
- Under corrosive gas environment
- Under the environment temperature below 5°C
- Under the environment temperature over 30°C
- Under the high humidity environment over 85%
- Under the environment exposing the Skiver to steam or water splash

5. Storage Environment

Ambient Temperature	0 to 40°C (no condensation)
Ambient Humidity	15 to 85% RH
Place of Use	Indoors (free from dust, water)
Environment No	No flammable, ignitable or corrosive gas, no steam



- **When the Skiver is not used, store it in the above environment.**

Poor storage may cause mechanical failure and result in a fire or an electric shock.



- **Make sure to conduct pre-operation safety checks to ensure that the Skiver works properly.**

In the event that you find any abnormality in the pre-operation checks, immediately contact Nitta or your local distributor or agent in your area for service.

6. Name of Parts

6-1) Main unit of Poly Skiver

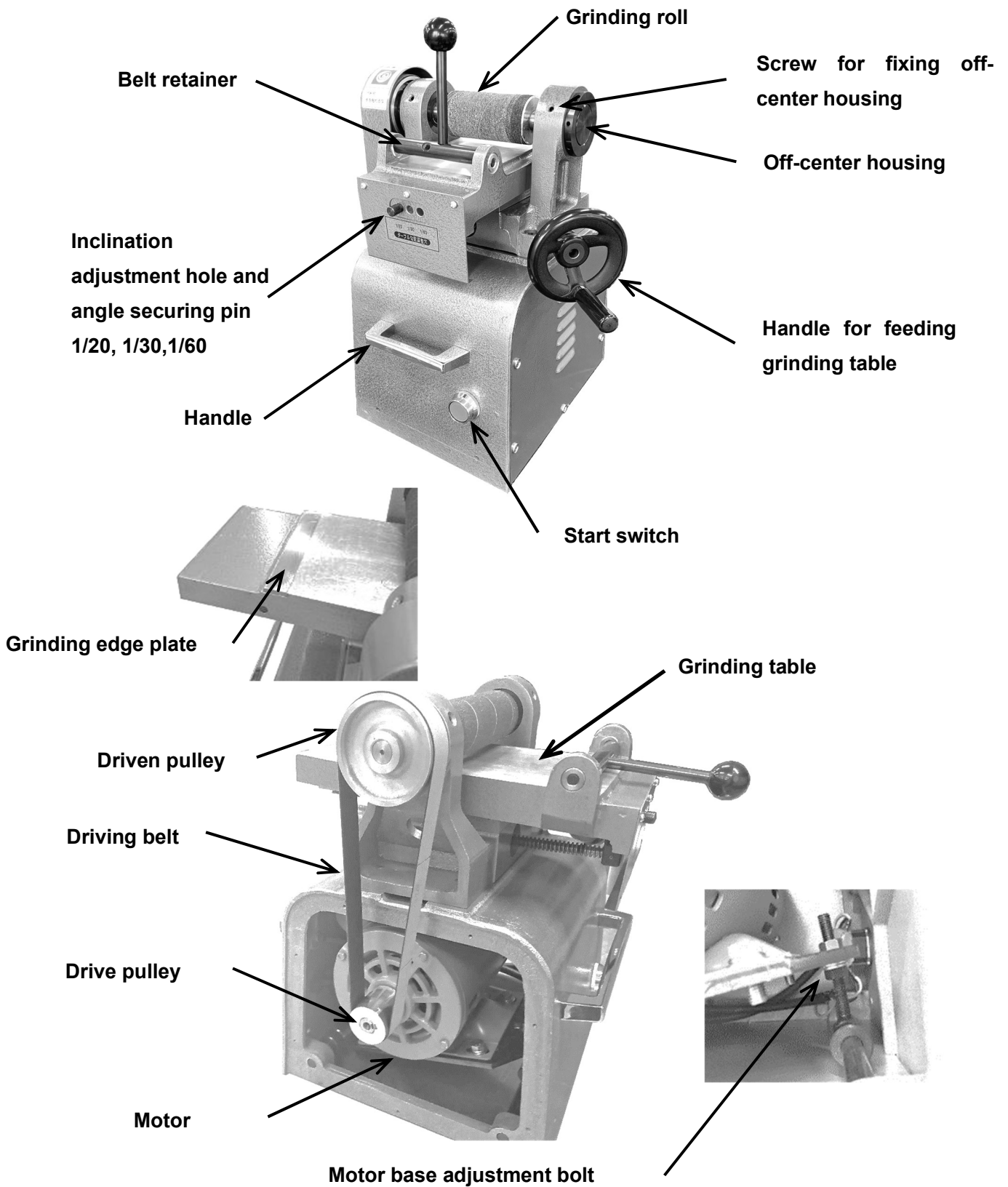

7. Preparation

Make sure to complete the following preparation before operation.

7-1) Fixing the Skiver on the workbench

The Skiver is a tabletop type. Before using the Skiver, fix it on the workbench.

Fix the supplied bracket on the main unit, and then fix the bracket fixing hole and the workbench with a M8 bolt.

You must use a steady workbench.

Use the workbench that endures the Skiver weight (26 kg) and the vibration during operation.

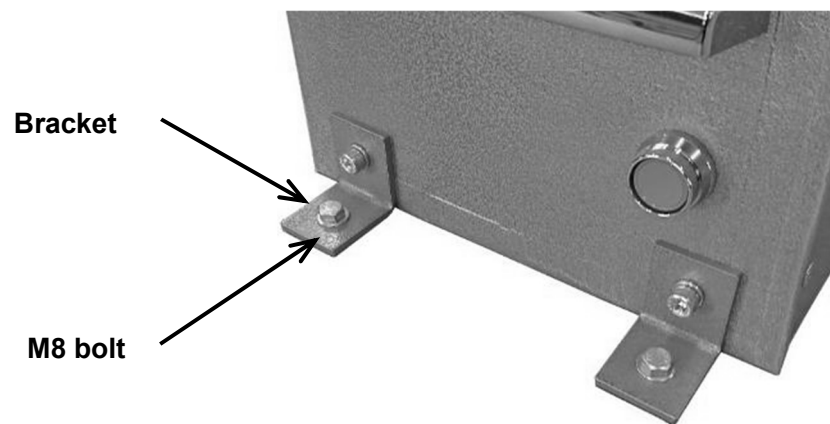

7-2) Power supply connection

Make sure to ground the power source of the Skiver.

Also make sure to use the power equipped with a ground fault interrupter.

An A type power plug is connected for the 100V specification.

Use the outlet conforming to the power plug or the conversion adapter of the plug to connect.

7-3) Extension of power cord

When you need to extend the power cord, use the extension cord with a cord thickness (cross section of core wire) of 2 mm² or more.

Also use the 3-core (including 1 conductor for grounding) cable.

7-4) Checking gap between grinding roll and grinding table

Owing to the impact during transportation, the gap adjustment may have a misalignment between the grinding roll and the grinding table.

Before starting the operation, make sure to check that the grinding roll and the grinding table have not been collided.

Refer to page 15 in this manual for the adjustment procedure.

8. How to use

8-1) Precaution of grinding work

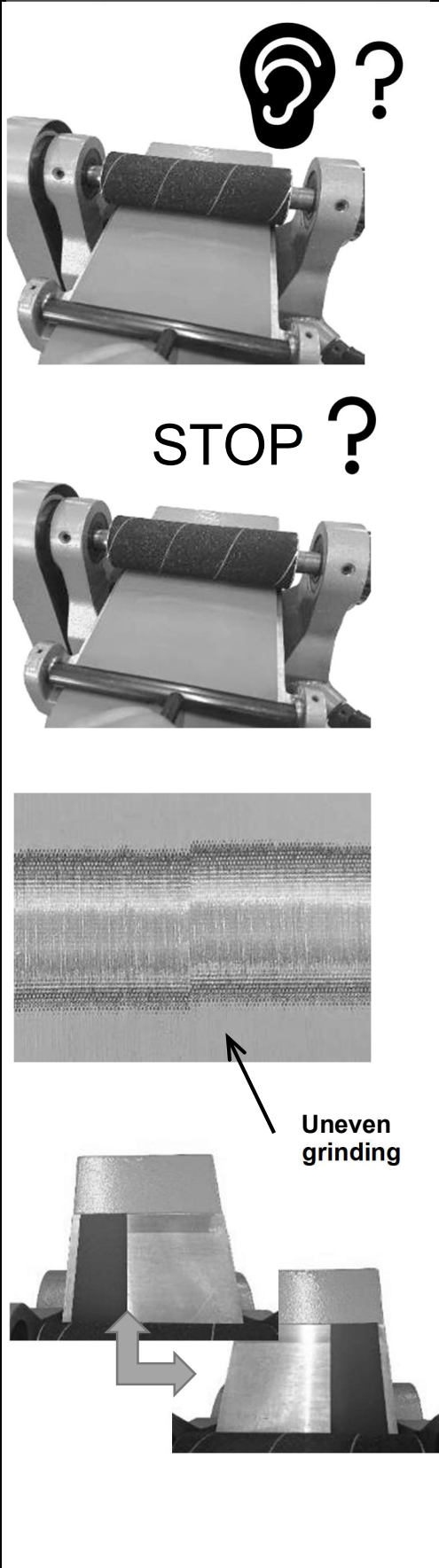

- If abnormal vibration or abnormal noise occurs during the operation, immediately stop the operation and contact Nitta or your local agent.

- When grinding a wide or thick belt, the grinding roll may stop owing to a load.
If the drive belt has slipped, adjust the belt tension of the driving belt or replace it.
Refer to page 16 in this manual for the replacement procedure of the driving belt.

- Grinding a thin belt only at the same point of the grinding roll wears only the point of the sandpaper. The worn point will grind unevenly when grinding a wide belt.
Change the grinding point each time when grinding a thin belt to wear the sandpaper of the grinding roll evenly.

8-2) Preliminary check

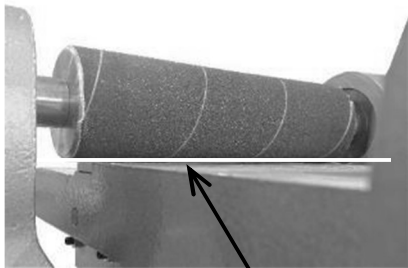
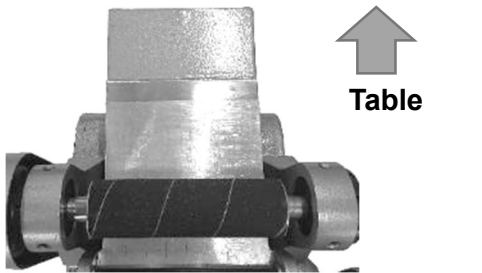

Collision



Changing inclination angle of grinding table

- [1] Incline the grinding table according to the belt type.
Feed the grinding table to the far side.
Insert an angle securing pin into an inclination fixing hole of the specified grinding table angle.
* Refer to the Nitta endless manual for the inclination for each belt type.

- [2] After changing the inclination of the grinding table, check that the grinding roll and the grinding table do not collide.
Slowly move the grinding table toward you while checking that the grinding roll does not collide with the grinding table.
Slight rotation of the grinding roll indicates that the grinding table and the grinding roll have collided.
Refer to the maintain procedure on page 15 in this manual.

Checking grinding times

- [3] Determine the number of times to grind according to the thickness of the belt.
The most suitable thickness to grind in one stroke is 2 mm or less.

Belt thickness and grinding number

2 mm or less	2.1 to 4mm	4.1 to 6 mm
once	two times	three times

- * Forceful grinding prevents the accurate processing of joints as well as heats up the grinding roll and overloads the motor, resulting in troubles.

The following page describes the two-time and three-time grinding.

8-2) Preliminary check (continued from page 14)

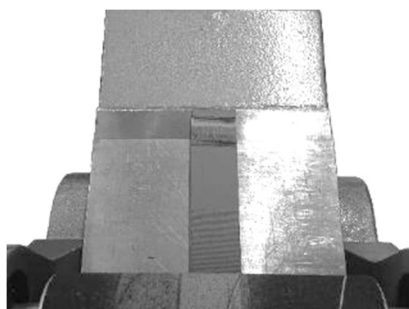
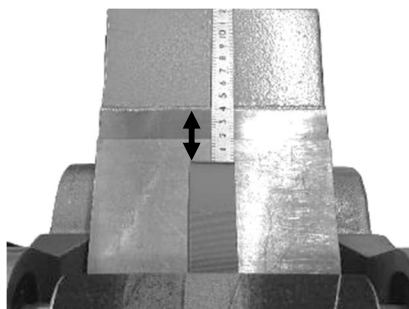
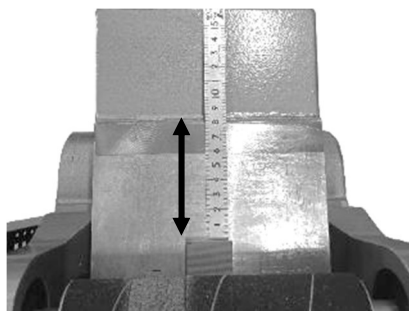
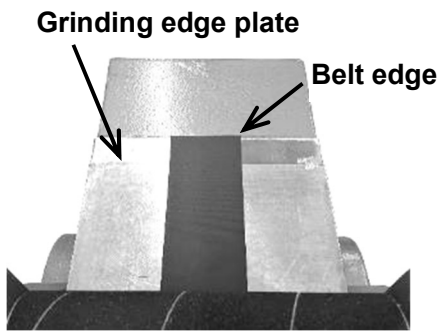

[1] Adjust and set the belt edge to grind to the edge of the edge plate of the grinding table.
For the two-time and three-time grinding, offset the belt edge from the grinding edge plate, and then set the belt.

[2] Example) Grind the XH-500-6 (6 mm thickness) three times, and then complete the joint.
The joint length of the XH-500-6 is 120 mm. For the first grinding, adjust the belt edge at the position offset 80 mm from the edge of the grinding edge plate.

[3] For the second grinding, adjust the belt edge at the position offset 40 mm from the edge of the grinding edge plate.
* For the belt in thickness of 2.1 mm to 4 mm, start from this procedure.

[4] For the final grinding, adjust the belt edge to the grinding edge plate, and then grind.

8-3) Grinding work

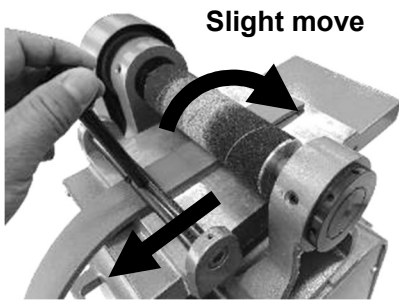

Slight move

Move the table toward you.

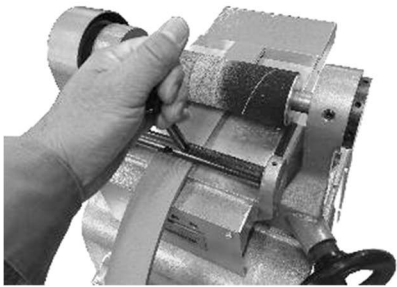

Keep the belt fixed during grinding.

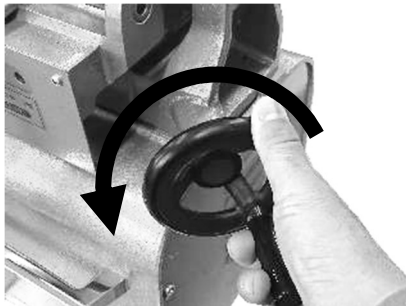

6 to 10 seconds for one rotation.

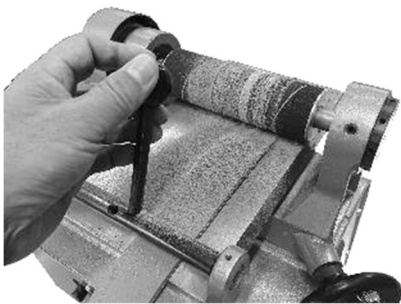

Release the belt after the rotation has stopped.

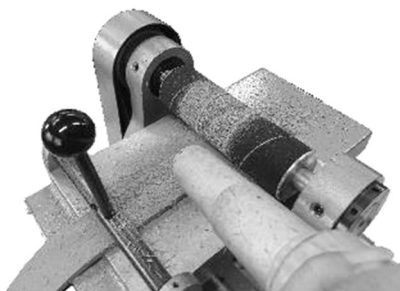

Clean the Skiver often.

[1] Set the belt and then fix the belt with the belt clamp lever. Then move the grinding table toward you, and make the grinding roll contact the belt. Then slightly move the grinding table further so that the grinding roll moves slightly, and then stop the grinding table.

* Do not start the motor.

[2] Tilt and keep the belt clamp lever toward you, and turn on the start switch of the motor.

* Keep the belt fixed during the grinding roll rotation.

Rotate the grinding roll, and then slowly move the grinding table toward you to shave the belt.

The proper feeding speed is about 6 to 10 seconds so that the handle rotates once.

* Wear safety goggles when grinding belts.

* Wear a mask if necessary.

* Do not wear gloves. Otherwise, the gloves and you may be caught in the grinding roll.

[3] After grinding the belt edge, turn off the start switch of the motor to stop the rotation of the grinding roll. Check that the rotation of the grinding roll has stopped completely, and then loosen the belt clamp lever.

[4] Clean grinding powder with a dust collector or a brush.

[5] For the two-time and three-time grinding, repeat the procedure [1] to [4].

* For processing the joint of the belt over 3mm in thickness, check the temperature of the grinding roll each time so that the temperature of the grinding roll keeps below 80°C. When the temperature of the grinding roll has exceeded 60°C at the time of the grinding start, the temperature of the grinding roll may exceed 80 degrees C during grinding. Cool the grinding roll sufficiently, and then start grinding.

9. Maintenance

9-1) Adjusting gap of grinding roll

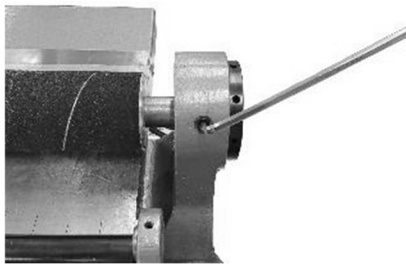
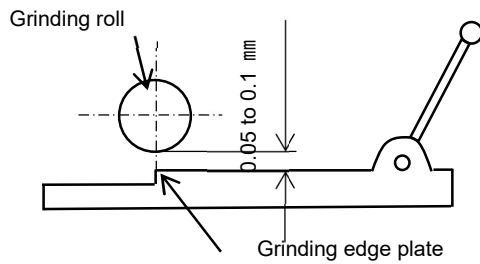

Loosening fixing screw



Fine adjustment of height

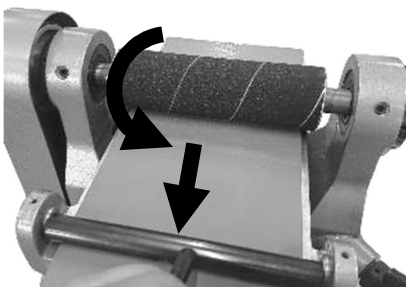

Height where the grinding roll rotates only for a moment with the spread PET sheet

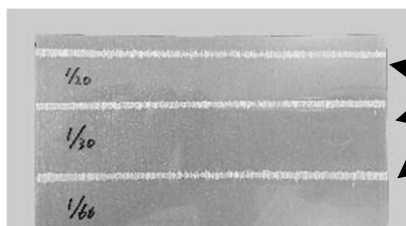

Adjust the height of the grinding roll so that the gap between the grinding roll and the grinding edge plate is 0.05 to 0.1 mm.

Adjust the height after replacing the sandpaper, in case of uneven joint grinding or a thick joint edge.

* Adjust the height carefully not to damage the grinding edge plate.

Use a 4mm hex wrench, an off-center housing adjustment tool (supplied), PET film (supplied) when adjusting the height of the grinding roll.



WARNING Prior to the adjustment, make sure to unplug.

[1] Loosen the 4 screws for fixing off-center housing with a hex wrench, lift up the grinding roll with an off-center housing adjustment tool so that the grinding roll does not collide with the grinding edge plate.

[2] Place the PET sheet on the grinding table, and then adjust the height so that the grinding roll rotates only at the moment when it touches the PET sheet when the grinding table is moved back and forth.

[3] Rotating the grinding roll electrically and grinding the PET sheet clearly shows the adjustment condition.

Proper condition is that a grinding mark remains on the PET sheet in 2 to 3 mm width uniformly.

Grinding mark by grinding roll remaining on the PET sheet

9-2) Replacement and tension adjustment of driving belt

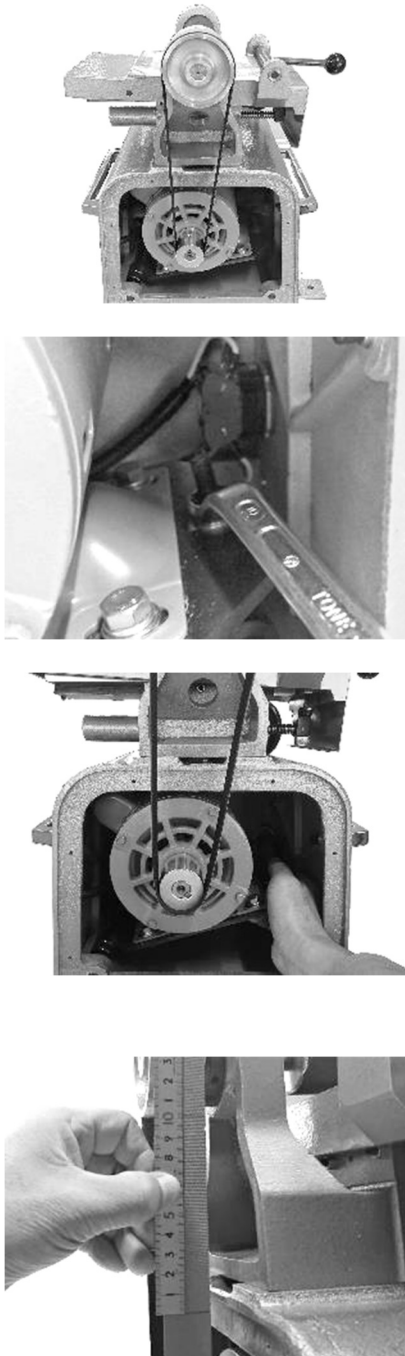

You must properly adjust the tension of the driving belt to transmit the motor drive to the grinding roll.

Note that the driving belt excessively tension the life of the belt as well as damages the motor and the bearing of the grinding roll.



Prior to the tension adjustment, make sure to unplug.

[1] Remove the cover of the driving belt with a Phillips screwdriver.

[2] Loosen the fixing nut of the motor base adjustment bolt (upper side of the motor base) with a spanner.

[3] Slightly lift the motor base, and then remove the old belt and replace with a new belt.

Check the rotation direction when fixing a new belt. (The belt rotates clockwise when viewing the Poly Skiver from outside. Adjust the arrow indicating the rotation direction of the belt to clockwise direction.)

[4] Tighten the fixing nut of the motor base adjustment bolt to adjust the belt tension.

While checking the calibration mark on the belt with a steel rule, adjust the belt tension so that the distance between the calibration marks is 101 mm. Measure the calibration mark distance after rotating the belt once.

Securely tighten the fixing nut, and then fix the cover.

9-3) Recovering sandpaper of grinding roll

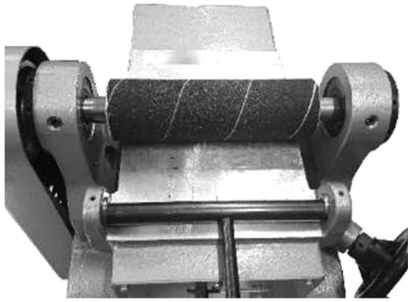

Move the table to the far side.

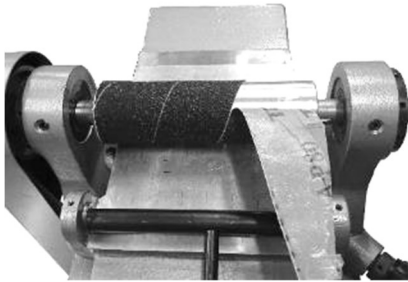

Peel the sandpaper.



Remove an adhesive.



Paste from the edge without gap.



Absolutely contact to the roller.

The sandpaper is worn out each time you use it. Grinding takes time. Replace the sandpaper when you find the conditions such as a long grinding time, easy heating of the grinding roller, or uneven belt grinding.



WARNING

Prior to the replacement, make sure to unplug.

[1] Move the grinding table to the far side to prevent the sandpaper from colliding with the grinding edge plate, and then peel the old sandpaper from the end.

[2] Completely remove the adhesive tape remaining on the grinding roll using a label remover.

A slight adhesive tape remaining on the grinding roll causes uneven belt grinding as well as damages the grinding edge plate. Securely remove the tape.

[3] While gradually removing the pasted board behind the sandpaper, Paste the sandpaper on the grinding roll.

Paste the sandpaper so that the sandpapers do not have any gap or overlapping between them.

You should paste the sandpaper with pulling to prevent wrinkles.

[4] After pasting the sandpaper, grind the edge waste of the belt to fit the adhesive tape.

Grind the belt halfway before completing to the edge of the belt, and then absolutely contact the sandpaper and the grinding roll. If you find any uneven grinding, paste the sandpaper again.

[5] After replacing the sandpaper, adjust the gap between the grinding rolls described on page 15.

10. Troubleshooting

Phenomenon	Cause	Remedies
Grinding roll does not start.	Power plug has been pulled out.	Plug the cord.
	The power cable is broken.	The Skiver need repair. * Contact Nitta.
	Failure of motor or switch.	The Skiver need repair. * Contact Nitta.
	Breakage or sag of driving belt.	Replacement or adjustment of driving belt.
Abnormal noise or vibration	Loosened screw. Degraded or broken rotary part.	Retighten the screws of each part. If the phenomenon still remains, stop using and contact Nitta.
Uneven grinding of joint	Worn sandpaper.	Replace the sandpaper.
High heat generation of grinding roll	Fast feeding speed of grinding table. Continuous grinding. Worn sandpaper	The proper feeding speed of the grinding table is 6 to 10 seconds so that the handle rotates once. For the continuous grinding, check the temperature of the grinding roll. When the temperature of the grinding roll has exceeded 60°C, wait until the temperature decreases. Worn sandpaper easily produces heat. Replace the sandpaper with a new one.

11. Inspection

Inspection items	date/staff	date/staff	date/staff	date/staff	date/staff
The power cable has no damage.					
The power plug has no damage.					
All screws are securely tightened and fixed.					
Sandpaper has no peeling or damage.					
The switch turns ON/OFF properly.					
No abnormal noise during operation.					

* Make a copy of this page and use it for pre-operation checks.

12. Warranty and after-sales service

1. Warranty period

The warranty period is for one full year after the delivery of the order at your appointed place.

2. Warranty coverage

1) Should the product malfunction due to causes for which our company is responsible during the abovementioned warranty period, our company will provide a replacement product or repair the product free of charge. However, even within the warranty period the following cases shall not be covered by the warranty. Please note that even if our company provides a replacement product or repairs the product, the warranty period will be calculated from the initial date on which the product was delivered.

- ① Malfunction arising from any inappropriate conditions, environment, handling and usage which are not described in the Operation Manual and the Endless Splicing Procedure.
- ② Malfunction due to a cause arising from something other than the product, such as your own device.
- ③ Malfunction arising from any remodeling or repairing by other than our own company.
- ④ Malfunction arising from any reasons unpredictable due to our level of chemistry and technology before shipment.
- ⑤ Malfunction arising from fire, earthquake, flood, other disasters, voltage error, or other external factors for which our company bears no responsibility.
- ⑥ Malfunction where it can be confirmed that, if perishables stipulated by the Operation Manual and the Endless Splicing Procedure had been maintained and/or replaced correctly, prevention of the malfunction would have been possible.

2) The warranty does not apply to perishables. When perishables which have a limited lifetime are repaired, and should those perishables be determined by our company to have reached the end of their lifetime, the perishables will be replaced for a fee.

- ① Parts which fall under the category of perishables: "Sandpaper".
- ② Parts which fall under the category of perishables having a limited lifetime: "Driving belt" "Motor" "Bearing".

3) The warranty coverage is limited to what is stated in 1) above, and the warranty does not cover secondary damages (equipment damage, opportunity loss, profit loss) and any other damage incurred by the user as a result of a malfunction of the product.

4) After the warranty period, if after examination the product is repairable, our company will repair it upon request.

NITTA CORPORATION

4-4-26 Sakuragawa Naniwa-ku, Osaka 556-0022 Japan
Phone:+81-6-6563-1225 Fax:+81-6-6563-1242

<https://www.nitta.co.jp/en>

NITTA CORPORATION OF AMERICA

7605 Nitta Drive, Suwanee, GA 30024, U.S.A.
Phone:+1-770-497-0212 Fax:+1-770-623-1398
<http://www.nitta.com>

NITTA CORPORATION OF HOLLAND B.V.

Berenkoog 25, 1822 B.H. Alkmaar, The Netherlands
Phone:+31-72-5622234 Fax:+31-72-5613238
<http://www.nitta.nl>

NITTA (SHANGHAI) MANAGEMENT CO., LTD

Room 2705, Shenggao International Building, No.137 Xianxia Road, Shanghai 200051 CHINA
Phone:+86-21-6229-6000 Fax:+86-21-6229-9606
<http://www.nitta-cn.com>

NITTA CORPORATION INDIA PVT. LTD.

Gat No 191, 192, and 193, Plot No B, Village Vadhu Khurd, Taluka Haveli Dist Pune-412216, INDIA
Phone:+91-20-6731-3400 Fax:+91-20-6731-3401
<http://www.nitta.co.in>

KOREA NITTA MOORE CORP.

53, Suchul-daero 5-gil, Gumi-si, Gyeongbuk-do, 39266, KOREA
Phone:+82-54-461-5575 Fax:+82-54-461-5350
<http://www.nitta.co.kr/>

TAIWAN NITTA FILTER CO. LTD.

Headquarters: Chia Hsin Building 10FL Room No. 1005, 96 Chung Shan North Road Section 2, Taipei, Taiwan
Phone:+886-2-2581-6296 Fax:+886-3-469-0260
<http://www.nitta.com.tw>

NITTA INDUSTRIES EUROPE GmbH

Heerdter Lohweg 35, 40549 Dusseldorf, Germany
Phone:49-211-537535-0 Fax:+49-211-537535-35
<http://www.nitta.de>

NITTA CORPORATION OF SINGAPORE PTE LTD.

120 Lower Delta Road, #05-07/08
Cendex Centre, Singapore 169208
Phone:+65-6438-8738 Fax:+65-6438-8793
<http://www.nitta.com.sg>
<Liaison Office> Indonesia, Vietnam

NITTA CORPORATION (THAILAND) LIMITED

7/472 Moo 6, Tambol Mabyangporn, Amphur Pluakdaeng, Rayong Province 21140, THAILAND
Phone:+66-38-018-301 Fax:+66-38-018-304
<http://www.nittathai.com>

NITTA BRASIL

Rua Francisco Mommenshon, 50B, Galpão 02
Laranjeiras, Caieiras, São Paulo, Brazil
Phone/Fax:+55-11-4441-2922
<http://www.nitta.com.br>

CONNECT CONVEYOR BELTING INC.

405 Industrial Drive Unit 3-8, Milton, Ontario Canada L9T 5B1
Phone:+1-905-878-5552 FAX:+1-905-878-0344
<http://www.connectbelting.com>