





PM-NIT-16005E

NittaBeltPoly Heat Press PP300 Operation Manual



-  Follow this manual when using NittaBeltPoly Heat Press.
-  Please pass this manual to NittaBeltPoly Heat Press users for a safe and trouble-free operation.

NITTA CORPORATION

Contents

1. Safety Precautions	2
2. Confirmation of Product	5
3. Specifications	6
4. Use Environment	7
5. Storage Environment	7
6. Name of Each Part	8
7. How to Operate NittaBeltPoly Heat Press	9
8. How to Make Belts Endless	10
9. Troubleshooting	12
10. Inspection	13
11. Warranty and after-sales service	14

1. Safety Precautions

Please go over these safety precautions carefully to secure a correct and safe operation of the NIttaBeltPoly Heat Press PP103.



WARNING

Disregarding instructions marked with this symbol may lead to death or serious injury.



CAUTION

Disregarding instructions marked with this symbol may lead to injury or property damage



WARNING



WARNING

Do not use the Heat Press for any application other than the intended purpose of making belts endless.

Use for any unintended purpose may cause an unexpected accident. Failure to do this may cause fire, electric shock or injury.



WARNING

This machine is not intended for the physical, sensory or mental handicapped persons use.

They must have the supervision of a person responsible for their safety, if they use this Heat Press.

Failure to do this may cause fire, electric shock or injury.



WARNING

Do not allow the child to handle this Heat Press.

Keep this machine in the place where child's hand does not reach.

Failure to do this may cause fire, electric shock or injury.



WARNING

A person with experience and skills should always operate, maintain and inspect the Heat Press.

Handling by an inexperienced person may cause fire, electric shock or injury.



WARNING

Do not dismantle or remodel the Heat Press in any event. Dismantling or remodeling the Heat Press may cause fire, electric shock or injury.

For repair or inspection, please contact your local distributor or agent in your area.



WARNING

In case of an emergency (such as smoke, fire, foul smell), disconnect the main plug from the socket outlet and contact Nitta or your local distributor or agent in your area for inspection.

Failure to disconnect the main plug from the socket outlet may cause fire or electric shock.



Confirm that the power source used is within the designated specifications of the Heat Press.

Use beyond the designated specifications may cause fire or electric shock.

Specification	Power Source	Wattage Rating
For 100V	100V–110V 50/60Hz	455-550W
For 200V	200V–220V 50/60Hz	455-550W



To prevent fire or electric shock, do not use the Heat Press under the following conditions:

- Under flammable gas or combustible gas environment
- Under a corrosive gas environment
- Under an ambient temperature of 5°C or below
- Under an ambient temperature of 30°C or above
- Under a high humidity environment. (Humidity surpassing 85%)
- In places exposing the Heat Press to steam or water drops



Connect the main plug correctly to the socket outlet.

The power cable of the press uses an earth connection plug. Connect the main plug correctly into an earth connection outlet to prevent electric shock.



Use a conversion plug when the plug shape does not match the socket.

Failure to do this may cause electric shock.

The plug shape of the attached power cable is as follows. The conversion plug is not attached. When a conversion plug is necessary, users must provide their own.

Specification	Plug type	Plug illustration
For 100V	A Type	
For 200V	NEMA6-15	



Do not use the Heat Press on a flammable material.

Use of any other product may cause fire.



Impressed voltage is distributed in the power cable.

To prevent fire, electric shock or damage, please consider the following.

- Disconnect the main plug from the socket outlet with your hand.
- Do not remodel or replace the main plug.
- Do not place any object on the power cable.
- Do not fold the power cable.
- Do not pull or stretch the power cable.



Use a three-pin earth line as an extension cable.

When an extension cable is required, use an earth-connection type extension cable to prevent electric shock.



To prevent electric shock, do not operate the Heat Press with moistened hands.



Do not pour water on the Heat Press and do not get it wet.
Use of a wet press may cause fire or electric shock.



Always use anti-heat gloves when handling the Heat Press to prevent burns.

A label "Hot!" is on the top and bottom plates of the press to warn against high temperature.



Disconnect the main plug from the socket outlet immediately after use.

An operator should pay attention so that others do not touch the press carelessly and get burned before the Heat Press has cooled down.

It takes about one hours for a heated press (110°C) to cool down to 40°C in the room temperature of 25°C once it has been unplugged.



Use a dry cloth for cleaning the Heat Press.
To prevent fire, do not use alcohol, benzine, thinner or any other inflammable solvent.

Caution



Do not use the Heat Press outdoors.
This product is not intended for the use outdoors.



When using the Heat Press on any equipment, use a safety catcher for the press so it doesn't fall or collapse. This will help prevent fire, electric shock or injury.
This may cause fire or electric shock or injury.



Do not take place on the Heat Press the application of the adhesive.
This may cause fire or burns.



Before using the Heat Press be sure to inspect the press in accordance with the procedure described on page 13 to help prevent fire or electric shock.



Do not use this machine for the endless splicing of belt of other manufacturers.
Endless splicing may become imperfect if this machine is used for the endless splicing of belt of other manufacturers.
This may spoil the full functioning and performance of the belt.

2. Confirmation of Product

Thank you for choosing our Heat Press PP300



**Check that the product is exactly what you have ordered.
Use of the wrong product may cause fire, electric shock or injury.**

2-1) Confirmation of Product

Confirm the following items upon accepting delivery of your order. Contact your local sales office or distributor in your area if you find any deficiency or defect in your item.

- ① Are descriptions on the face plate the same as those of your order item?
Please confirm the model type and the power source specifications.
- ② Has the product been damaged during transportation?
- ③ Has a nut or screw slacked?

2-2) How to Read Face Plate

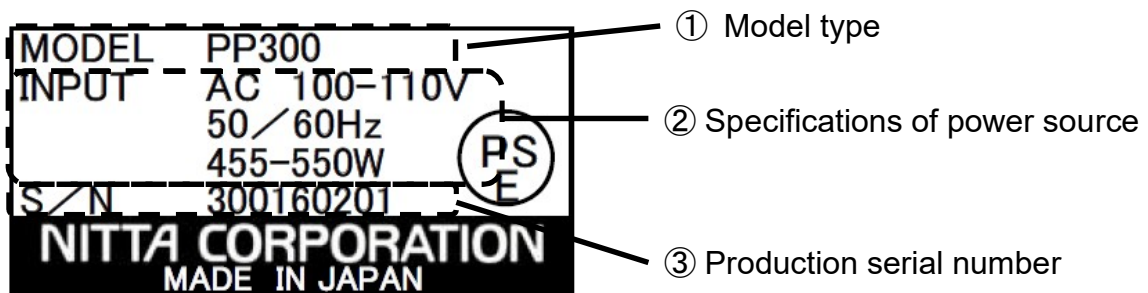

2-3) Notes for inquiry

When making inquiries, please contact us with both the press model and serial number.

2-4) Accessories

Operation Manual, Power cable, Cushion rubber, Release sheet, Thermometer, Hex wrench

3. Specifications

3-1) Outline of Heat Press

- ① Heat Press is exclusively designed for making endless **NittaBeltPoly** belts
- ② Heat Press is compatible with the following endless specifications:
 Joint specifications: skiver endless (Right angle)
 Maximum belt width: up to 300mm
 Maximum belt thickness: up to 5mm
- ③ Tools required for making skiver endless belts: NITTA Poly Skiver

3-2) Major Specifications of Heat Press

Type	PP300	
Specification of power source	100V	200V
Input power supply	100V~110V	200V~220V
	50/60Hz	50/60Hz
	455 - 550W	
Temperature	110°C	
Outer Dimension	155mm wide ×432mm long ×184mm high	
Weight	12kg	



WARNING

Check each time to the temperature of the press at the thermometer supplied.

4. Use Environment

Ambient Temperature	5-30 °C(no condensation)
Ambient Humidity	15~85%RH
Place of Use	Indoors (free from dust, water)
Environment	No flammable, combustible or corrosive gas; no steam

**WARNING**

In order to prevent fire or electric shock, do not use the Heat Press under the following conditions:

- Under flammable gas or combustible gas environment
- Under a corrosive gas environment
- Under an ambient temperature of 5°C or below
- Under an ambient temperature of 30°C or above
- Under a high humidity environment (humidity surpassing 85%)
- In places exposing the Heat Press to steam or water drops

5. Storage Environment

Ambient Temperature	0-40 °C (no condensation)
Ambient Humidity	15~85%RH
Place of Use	Indoors (free from dust, water)
Environment	No flammable, combustible or corrosive gas; no steam

**WARNING**

The Heat Press which is not in use should be stored subject to the above conditions.

Wrong or poor storage may cause mechanical disorder to the press and may cause fire or electric shock.

**WARNING**

Before using the Heat Press, perform a prior-to-use inspection and confirm that the press is working properly.

Any problem found in the prior-to-use inspection should immediately be notified to your local sales office or distributor in your area.

6. Name of Each Part

6-1) Main Press Body

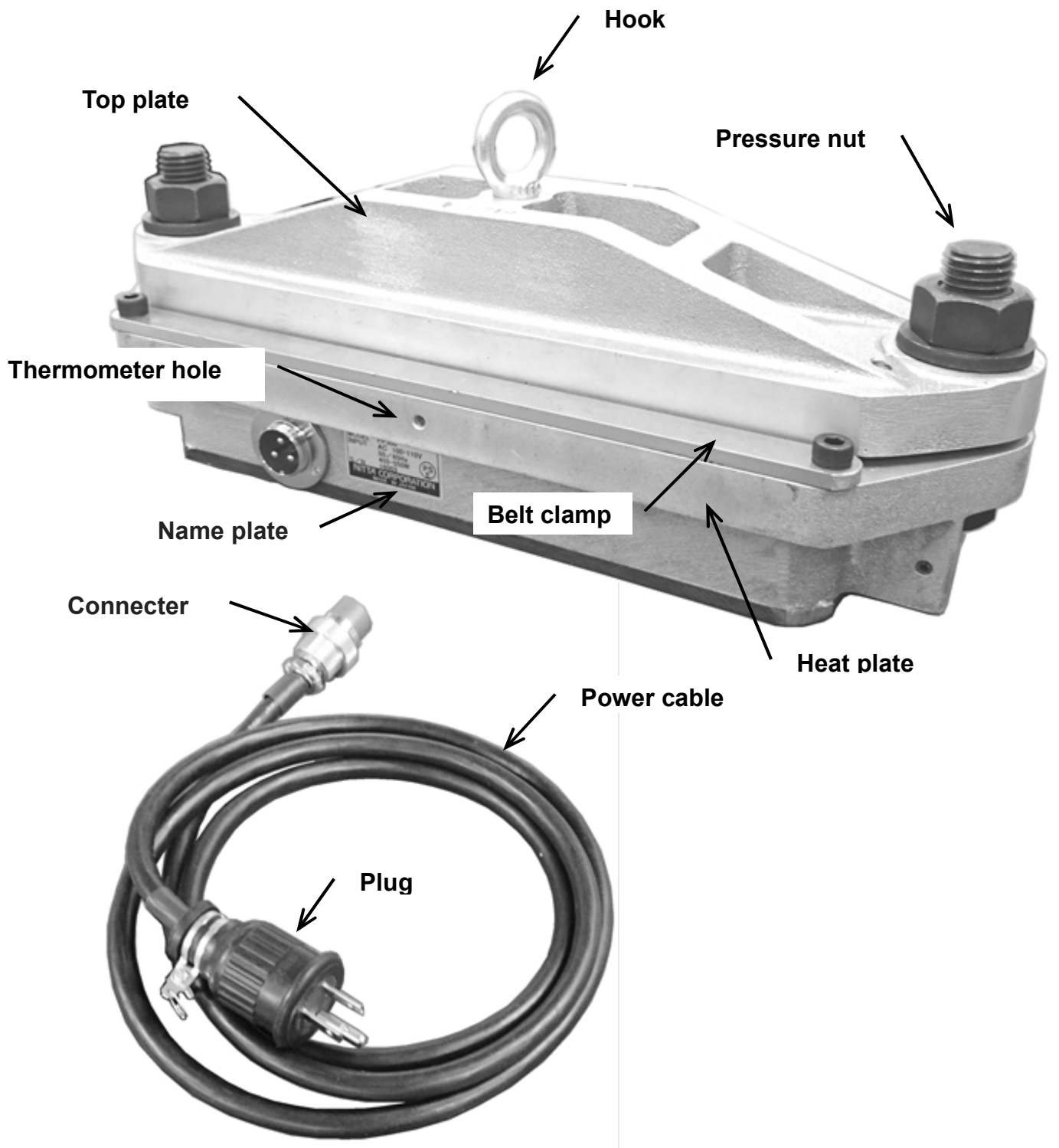

7. How to Operate NittaBeltPoly Heat Press

7-1) Required Tool

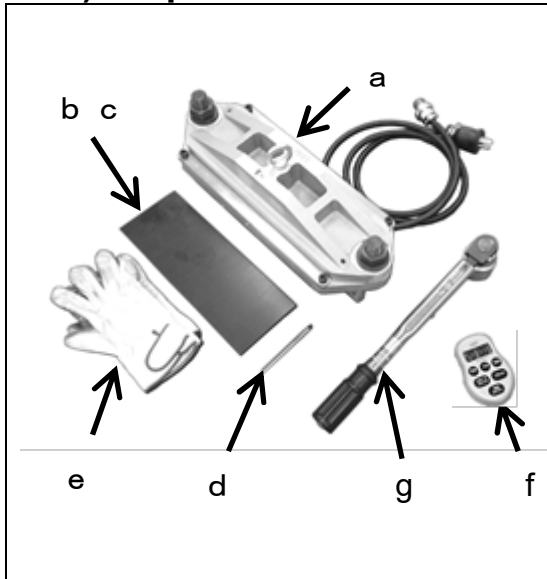

- a. Heat Press (PP300)
- b. Cushion rubber (PP300 contained)
- c. Release sheet (PP300 contained)
- d. Thermometer (PP300 contained)
- e. Anti-heat Gloves (burn-preventive protection kits)



WARNING

The Heat Press body reaches a high temperature. Always use anti-heat gloves to prevent burns.

- f. Stopwatch or timer
- g. Wrench

7-2) Preheating



- The stacked sequentially cushion rubber, the Top plate on the lower heat plate.
- Connect the main plug correctly to an electrical outlet, it is done preheating.



WARNING

Be sure to connect an earth line to prevent electric shock.

- It is to a temperature suitable for endless about 60 minutes.
- Do not connect or disconnect the power plug ON / OFF of the press.



WARNING

Always use anti-heat gloves when handling the Heat Press to prevent burns.

This may cause burns.



WARNING

An operator should pay attention so that others do not touch the Heat Press carelessly.

This may cause burns or injury.

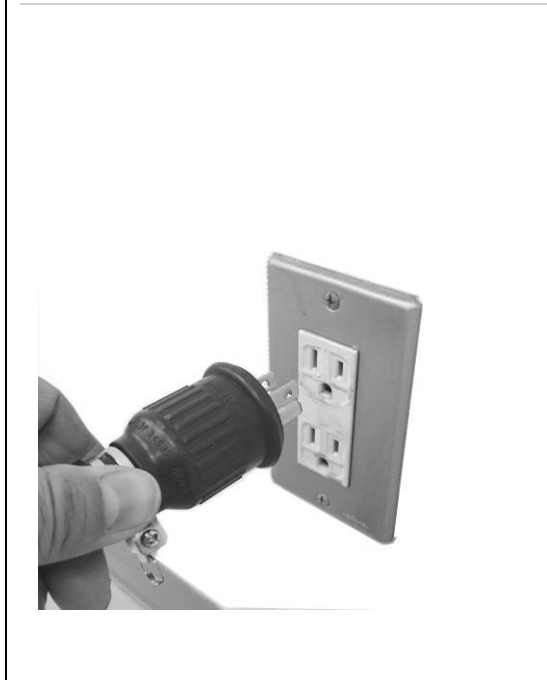

8. How to Make Belts Endless

8-1) Work Procedures

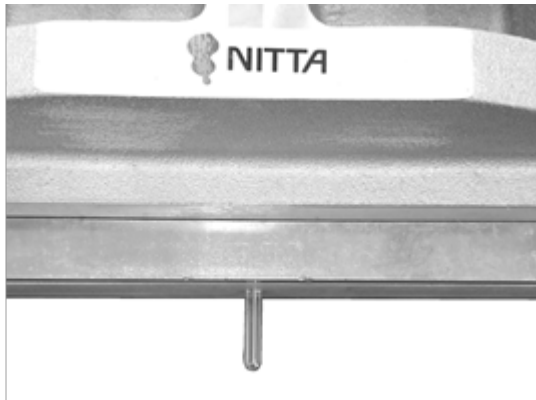

- Insert the thermometer in the thermometer hole.
- It is possible endless heat plate temperature is if it has been about 110 °C.



WARNING

Always use anti-heat gloves when handling the Heat Press to prevent burns.

- Apply the adhesive to the belt
✘**Check the splicing manual method of applying adhesive.**



CAUTION

Do not take place on the Heat Press the application of the adhesive.

- Is fixed to the center of the heat plate with upward skive surface of the belt.

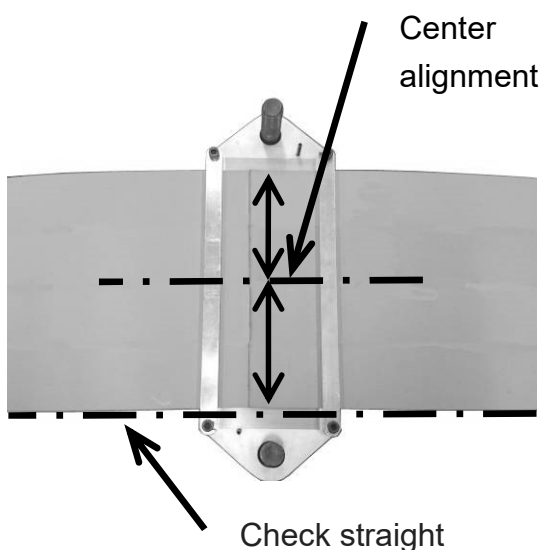

- Overlaid nylon core to match the belt the other.
- Make sure the joints are not bent at scale, to be fixed in the belt clamp the belt.
✘**Overlaid nylon core to match the belt the other.**

✘**Belt Centering the heat plate.**

Pressure is not applied uniformly belt has not been set in the center of the heat plate.

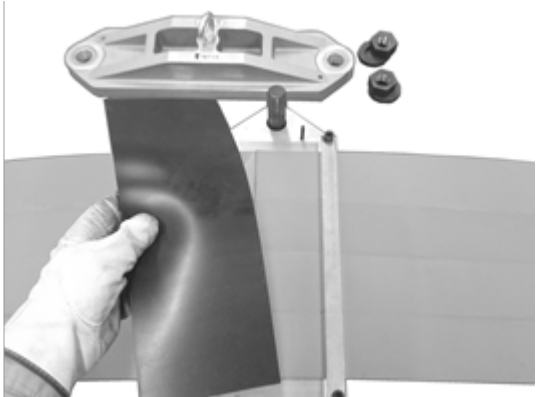
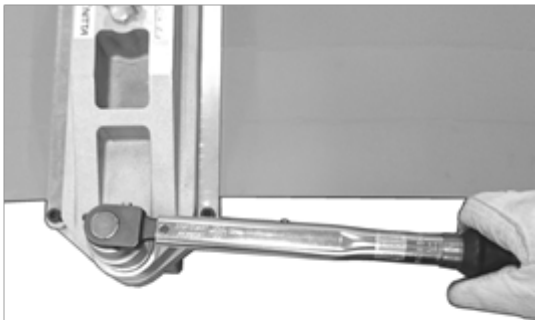

- Overlaid in the order of the release sheet, cushion rubber.
- Close the top plate.
Tighten lightly for pressure nut by hand.
- Confirm that the gap between the heat plate and the plate is equality.
- Evenly tighten the pressure nut with a wrench.
- ※Using a torque wrench, It obtained a stable pressure by checking the tightening torque.
Tightening torque about 40 at belt width 300, it is possible to ensure the appropriate surface pressure.
- During the heating time, which is described in splicing manual, hold the state in which the heated and pressurized.
- Releasing the pressing knob and remove the belt.
- The belt that was removed from the Heat press, Use it after cooling for 1 hour or more.

 **WARNING**

The Heat Press and belt are hot, It may cause burns.

 **WARNING**

The Heat Press after use, Unplug the power plug immediately and until cool to a safe temperature, please like other people not to touch carelessly.

9. Troubleshooting

Problem	Cause	Solution
The Heat Press does not heat.	The power plug has been disconnected.	Connect the power plug.
	Disconnection of the power cable.	Replacement of the power cable. ✘ Please contact us.
	Heat press does not heat up. (Fusing of thermal fuse, Circuit disconnection)	Replacement of the Heat Press. ✘ Please contact us.
	Temperature of the Heat Press greatly exceeds 110 °C. (Bad thermostat)	Replacement of the Heat Press. ✘ Please contact us.
Heating of the Heat Press is malfunction	Temperature of the Heat Press greatly exceeds 110 °C.	Replacement of the Heat Press. ✘ Please contact us.
Rotation of the pressure nut is not a smooth.	Oil out of the pressing nut.	Lubricate the pressure nut. Replacement is required if you are still unable to resolve the problem. ✘ Please contact us.

10. Inspection

Inspection items	date/staff	date/staff	date/staff	date/staff	date/staff
The power cable is free of damage or destruction.					
Main plug is free of damage or destruction.					
The Heat Press is free of damage or destruction.					
All screws of the Heat Press are tightened.					
The heat plate is free of foreign object.					
Rotation of the pressure nut is a smooth.					

※Make a copy of this page and use it for a prior-to-use inspection

11. Warranty and after-sales service

1. Warranty period

The warranty period is for one full year after the delivery of the order at your appointed place.

2. Warranty coverage

1) Should the product malfunction due to causes for which our company is responsible during the abovementioned warranty period, our company will provide a replacement product or repair the product free of charge. However, even within the warranty period the following cases shall not be covered by the warranty. Please note that even if our company provides a replacement product or repairs the product, the warranty period will be calculated from the initial date on which the product was delivered.

- ① Malfunction arising from any inappropriate conditions, environment, handling and usage which are not described in the Operation Manual and the Endless Splicing Procedure.
- ② Malfunction due to a cause arising from something other than the product, such as your own device.
- ③ Malfunction arising from any remodeling or repairing by other than our own company.
- ④ Malfunction arising from any reasons unpredictable due to our level of chemistry and technology before shipment.
- ⑤ Malfunction arising from fire, earthquake, flood, other disasters, voltage error, or other external factors for which our company bears no responsibility.

2) The warranty coverage is limited to what is stated in 1) above, and the warranty does not cover secondary damages (equipment damage, opportunity loss, profit loss) and any other damage incurred by the user as a result of a malfunction of the product.

3) After the warranty period, if after examination the product is repairable, our company will repair it upon request.

NITTA CORPORATION

4-4-26 Sakuragawa Naniwa-ku, Osaka 556-0022 Japan
Phone:+81-6-6563-1225 Fax:+81-6-6563-1242
<https://www.nitta.co.jp/en>



NITTA CORPORATION OF AMERICA

7605 Nitta Drive, Suwanee, GA 30024, U.S.A.
Phone:+1-770-497-0212 Fax:+1-770-623-1398
<http://www.nitta.com>

NITTA CORPORATION OF HOLLAND B.V.

Berenkoog 25, 1822 B.H. Alkmaar, The Netherlands
Phone:+31-72-5622234 Fax:+31-72-5613238
<http://www.nitta.nl>

NITTA (SHANGHAI) MANAGEMENT CO., LTD

Room 2705, Shenggao International Building, No.137 Xianxia Road, Shanghai 200051 CHINA
Phone:+86-21-6229-6000 Fax:+86-21-6229-9606
<http://www.nitta-cn.com>

NITTA CORPORATION INDIA PVT. LTD.

Gat No 191, 192, and 193, Plot No B, Village Vadhu Khurd, Taluka Haveli Dist Pune-412216, INDIA
Phone:+91-20-6731-3400 Fax:+91-20-6731-3401
<http://www.nitta.co.in>

KOREA NITTA MOORE CORP.

53, Suchul-daero 5-gil, Gumi-si, Gyeongbuk-do, 39266, KOREA
Phone:+82-54-461-5575 Fax:+82-54-461-5350
<http://www.nitta.co.kr/>

TAIWAN NITTA FILTER CO. LTD.

Headquarters: Chia Hsin Building 10FL Room No. 1005, 96 Chung Shan North Road Section 2, Taipei, Taiwan
Phone:+886-2-2581-6296 Fax:+886-3-469-0260
<http://www.nitta.com.tw>

NITTA INDUSTRIES EUROPE GmbH

Heerdter Lohweg 35, 40549 Dusseldorf, Germany
Phone:49-211-537535-0 Fax:+49-211-537535-35
<http://www.nitta.de>

NITTA CORPORATION OF SINGAPORE PTE LTD.

120 Lower Delta Road, #05-07/08
Cendex Centre, Singapore 169208
Phone:+65-6438-8738 Fax:+65-6438-8793
<http://www.nitta.com.sg>
<Liaison Office> Indonesia, Vietnam

NITTA CORPORATION (THAILAND) LIMITED

7/472 Moo 6, Tambol Mabyangporn, Amphur Pluakdaeng, Rayong Province 21140, THAILAND
Phone:+66-38-018-301 Fax:+66-38-018-304
<http://www.nittathai.com>

NITTA BRASIL

Rua Francisco Mommenshon, 50B, Galpão 02 Laranjeiras, Caieiras, São Paulo, Brazil
Phone/Fax:+55-11-4441-2922
<http://www.nitta.com.br>

CONNECT CONVEYOR BELTING INC.

405 Industrial Drive Unit 3-8, Milton, Ontario Canada L9T 5B1
Phone:+1-905-878-5552 FAX:+1-905-878-0344
<http://www.connectbelting.com>