

PolySprint™

Heat Press

NPS-0310H1/H2

Operation Manual



-  Follow this manual when using Nitta *PolySprint™* Heat Press.
-  Please pass this manual to *PolySprint™* Heat Press users for a safe and trouble-free operation.

NITTA CORPORATION

Contents

1. Safety Precautions	2
2. Confirmation of Product	6
3. Specifications	7
4. Use Environment	8
5. Storage Environment	8
6. Name of Each Part	9
7. How to Operate <i>PolySprint</i>[™] Heat Press NPS-0310H1/H2		11
8. How to Make Belts Endless	13
9. Troubleshooting	19
10. Inspection	20
11. Warranty and after-sales service	21

1. Safety Precautions

Please go over these safety precautions carefully to secure a correct and safe operation of the *PolySprint™* Heat Press NPS-0310H1/H2.



WARNING

Disregarding instructions marked with this symbol may lead to death or serious injury.



CAUTION

Disregarding instructions marked with this symbol may lead to injury or property damage.



WARNING



WARNING

Do not use the *PolySprint™* Heat Press for any application other than the intended purpose of making belts endless.

Use for any unintended purpose may cause an unexpected accident. A wrong operation may impair safety protection functions of the press.



WARNING

This machine is not intended for the physical, sensory or mental handicapped persons use. They must have the supervision of a person responsible for their safety, if they use this machine.

Failure to do this may cause fire, electric shock or injury.



WARNING

Do not allow the child to handle this machine. Keep this machine in the place where child's hand does not reach.

Failure to do this may cause fire, electric shock or injury.



WARNING

A person with experience and skills should always operate, maintain and inspect the *PolySprint™* Heat Press.

Handling by an inexperienced person may cause fire, electric shock or injury.



WARNING

Do not dismantle or remodel the *PolySprint™* Heat Press in any event.

Dismantling or remodeling the *PolySprint™* Heat Press may cause fire, electric shock or injury.

For repair or inspection, please contact your local distributor or agent in your area.



WARNING

In case of an emergency (such as smoke, fire, foul smell), disconnect the main plug from the socket outlet and contact Nitta or your local distributor or agent in your area for inspection.

Failure to disconnect the main plug from the socket outlet may cause fire or electric shock.

1 Safety Precautions- Continued-



Confirm that the power source used is within the designated specifications of the *PolySprint™* Heat Press.

Use beyond the designated specifications may cause fire or electric shock.

Type	Power Source
NPS-0310H1	100V – 120V 50/60Hz
NPS-0310H2	200V – 240V 50/60Hz



Connect the main plug correctly to the socket outlet.

The power cable of the press uses an earth connection plug. Connect the main plug correctly into an earth connection outlet to prevent electric shock.



Always use anti-heat gloves when handling the Heat Press to prevent burns.

A label “Hot!” is on the top and bottom plates of the press to warn against high temperature.

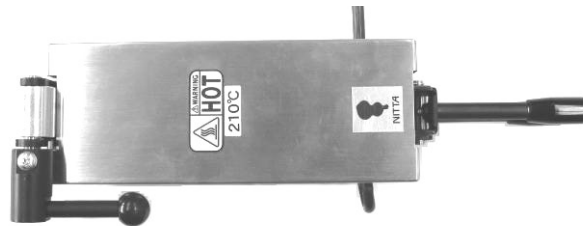

Do not touch any part of the press, other than its handle, even with anti-heat gloves on while the press is being heated or while it is still hot after using.

Metal edge portions beyond the handle shaft can exceed 100°C, which may cause burns even with anti-heat gloves on.



Disconnect the main plug from the socket outlet immediately after use. An operator should pay attention so that others do not touch the press carelessly and get burned before the press has cooled down.

It takes about two hours for a heated press (200°C) to cool down to 40°C in the room temperature of 25°C once it has been unplugged.



Do not use the Heat Press on a flammable material.



Always use a pre-setter supplied by Nitta.

Use of any other product may cause fire.

1 Safety Precautions- Continued-



Impressed voltage is distributed in the power cable and the control cable. To prevent fire, electric shock or damage to the cable, please consider the following:

- Disconnect the main plug from the socket outlet with your hand.
- Do not hang or carry the heat controller or the press by the power cable or control cable. Always hold the press body and heat controller.
- Do not remodel or replace the main plug.
- Do not place any object on the power cable or the control cable.
- Do not fold the power cable or the control cable.
- Do not pull or stretch the power cable or the control cable.
- Do not wrap the cable around the press and the controller.

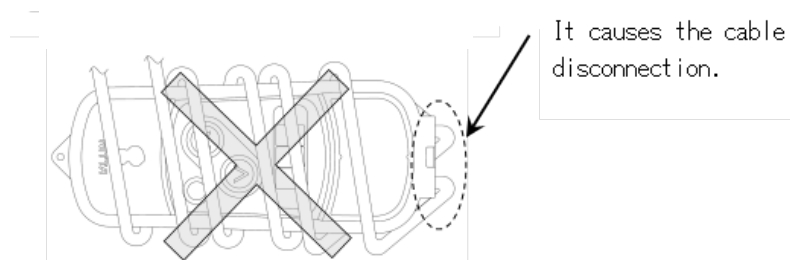

Use a three-pin earth line as an extension cord.

When an extension cord is required, use an earth-connection type extension cord to prevent electric shock.



To prevent fire or electric shock, do not use the *PolySprint™* Heat Press under the following conditions:

- Under flammable gas or combustible gas environment
- Under a corrosive gas environment
- Under an ambient temperature of 5°C or below
- Under an ambient temperature of 40°C or above
- Under a high humidity environment. (humidity surpassing 85%)
- In places exposing the press to steam or water drops



To prevent electric shock, do not operate the *PolySprint™* Heat Press with moistened hands.



Do not pour water on the *PolySprint™* Heat Press and do not get it wet.

Use of a wet press may cause fire or electric shock.



Use a dry cloth for cleaning the *PolySprint™* Heat Press. To prevent fire, do not use alcohol, benzene, thinner or any other inflammable solvent.

1 Safety Precautions- Continued-

Caution



Do not use the *PolySprint™* Heat Press outdoors.



Do not give the heat controller a strong shock.

This may cause fire or electric shock.



When using the *PolySprint™* Heat Press on any equipment, use a safety catcher for the press so it doesn't fall or collapse. This will help prevent fire, electric shock or injury.

The heat controller is equipped with suspension fittings.

Pass a hook or string through the suspension fitting and attach the heat controller to a sturdy and stable object.

Suspension fitting



Before using the *PolySprint™* Heat Press be sure to inspect the press in accordance with the procedure described on page 18 to help prevent fire or electric shock.

2. Confirmation of Product

Thank you for choosing our *PolySprint™* Heat Press NPS-0310H1/H2.



CAUTION

Check that the product is exactly what you have ordered. Use of the wrong product may cause fire, electric shock or injury.

2-1) Confirmation of Product

Confirm the following items upon accepting delivery of your order. Contact your local sales office or distributor in your area if you find any deficiency or defect in your item.

- ① Are descriptions on the face plate the same as those of your order item? Please confirm the model type and the power source specifications.
- ② Has the product been damaged during transportation?
- ③ Has a nut or screw slackened?

2-2) How to Read Face Plate

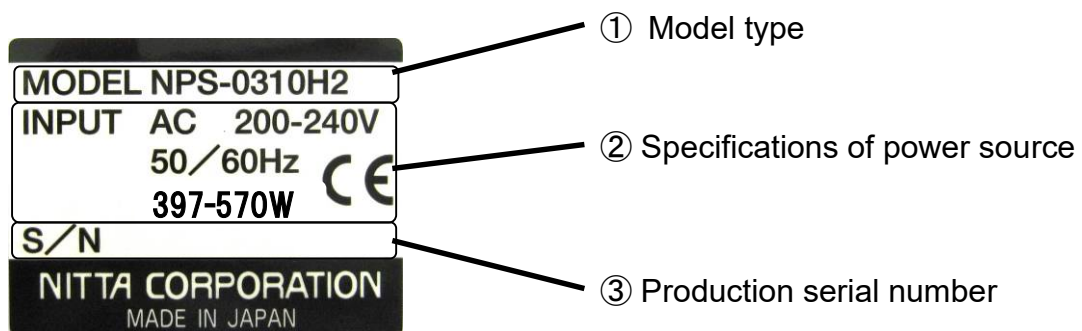

2-3) Heat Press Type

H1 or H2 appearing at the end of the press type indicates the specifications of the power source. H1 is compatible with AC100-120V, while H2 is compatible with AC200-240V.

2-4) Inquiries

When making inquiries, please inform our sales representative of the model type and the production serial number.

3. Specifications

3-1) Outline of Heat Press

- ① *PolySprint™* Heat Press is exclusively designed for making finger-endless Nitta *PolySprint™* belts and is made up of (1) springs that apply pressure to the belt (2) electronically controlled heating plates (3) digital heat controller with accurate readout.
- ② *PolySprint™* Heat Press is compatible with the following endless specifications:
 Joint specifications: finger shape 30mm long x 10mm pitch
 Maximum belt width: up to 100mm
 Maximum belt thickness: up to 2mm
- ③ Tools required for making finger endless belts: finger puncher FP30-10-100, cooling press NPS-0310C, pre-setter and pre-setter clamps.
※A pre-setter is required for each width belt that is to be made endless.

3-2) Major Specifications of Heat Press

Type	NPS-0310H1	NPS-0310H2
Power Source	100V-120V	200V-240V
	50/60Hz	50/60Hz
	397W-570W	397W-570W
Set Temperature	※0-210 °C	
Outer Dimension	Press Body:107mm wide x 365mm long x 112 mm high Controller: 90mm wide x 225mm long x 45mm high	
Weight	4.2kg (including heat controller)	

※The range of the set temperature of the controller is between 0°C and 210°C, but it can not control if it is below the room temperature. When making finger endless belts, the temperature should be set within the range of 170°C ~ 200°C.

4. Use Environment

Ambient Temperature	5-40 °C(no condensation)
Ambient Humidity	15~85%RH
Place of Use	Indoors (free from dust, water)
Environment	No inflammable, combustible or corrosive gas; no steam



In order to prevent fire or electric shock, do not use the *PolySprint™* Heat Press under the following conditions:

- Under flammable gas or combustible gas environment
- Under a corrosive gas environment
- Under an ambient temperature of 5°C or below
- Under an ambient temperature of 40°C or above
- Under a high humidity environment (humidity surpassing 85%)
- In places exposing the press to steam or water drops

5. Storage Environment

Ambient Temperature	0-40 °C (no condensation)
Ambient Humidity	15~85%RH
Place of Use	Indoors (free from dust, water)
Environment	No inflammable, combustible or corrosive gas; no steam



The *PolySprint™* Heat Press which is not in use should be stored subject to the above conditions.

Wrong or poor storage may cause mechanical disorder to the press and may cause fire or electric shock.



Before using the *PolySprint™* Heat Press, perform a prior-to-use inspection and confirm that the press is working properly.

Any problem found in the prior-to-use inspection should immediately be notified to your local sales office or distributor in your area.

6. Name of Each Part

6-1) Main Press Body

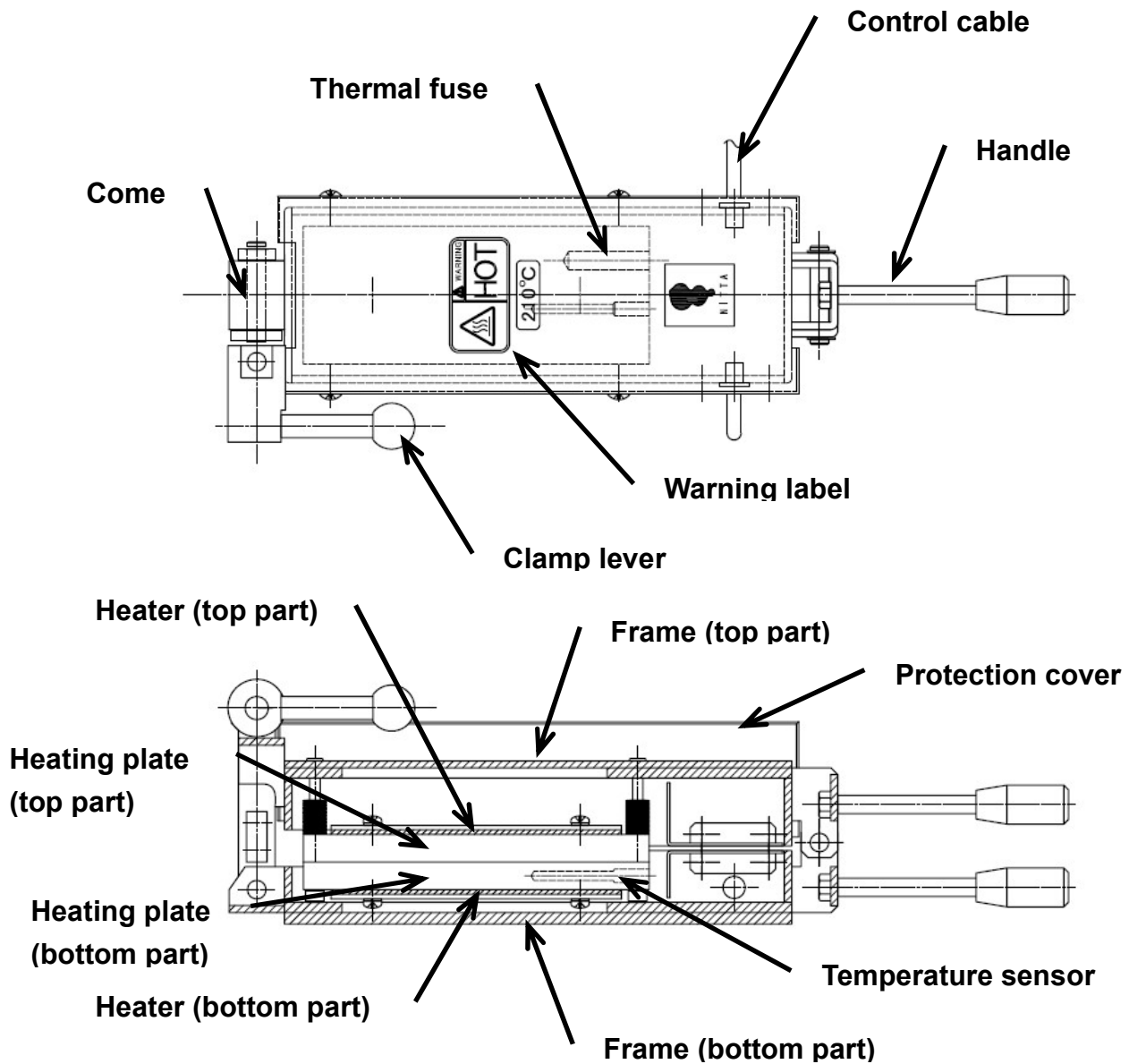

6. Name of Each Part- continued

6-2) Heat controller

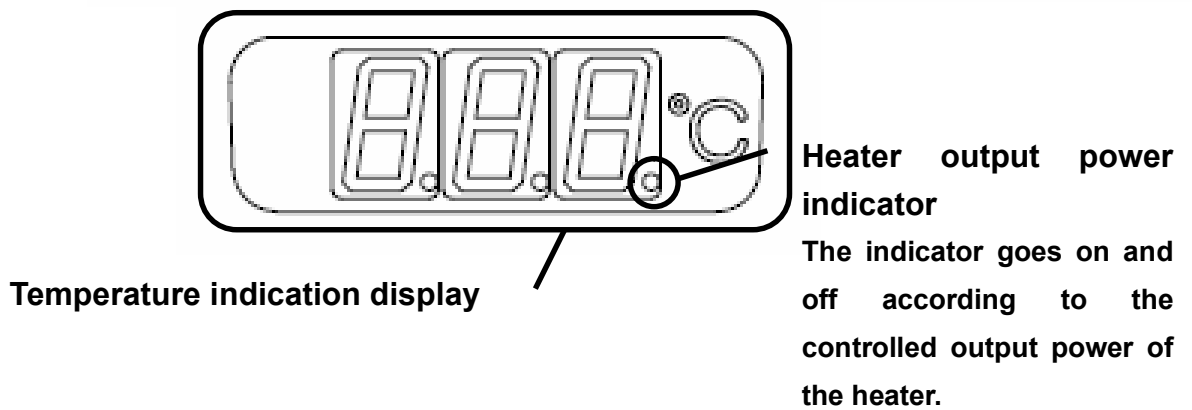
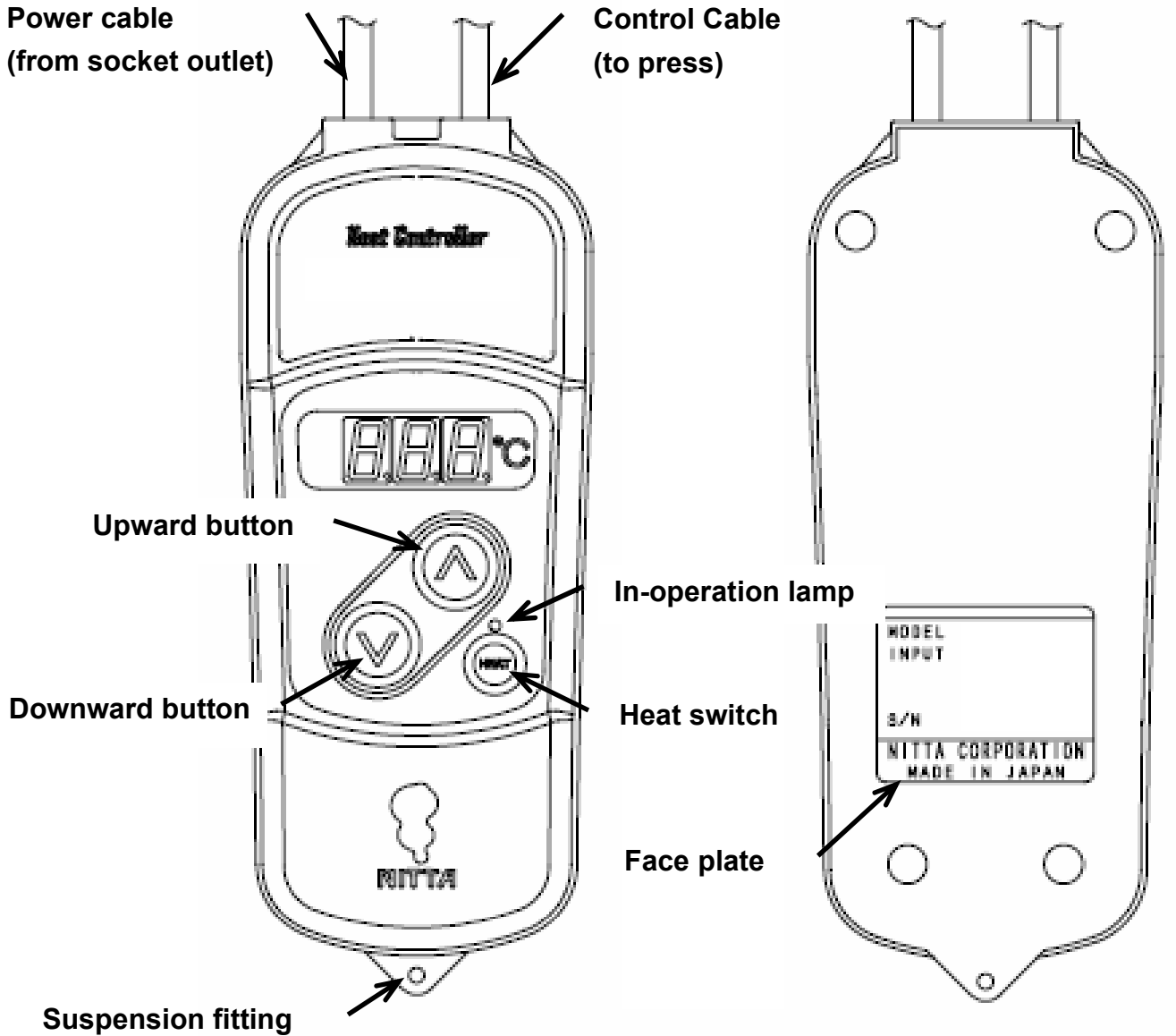

7. How to Operate *PolySprint*TM Heat Press

7-1) Power-on

Connect the main plug correctly to the socket outlet.



Power is supplied to the heat controller and the current temperature of the press is indicated on the heat controller. Now it is possible to confirm and change the set temperature.





Be sure to connect an earth line to prevent electric shock.

7-2) Temperature Setting (Heat Controller)

- ① Make sure first if the heat switch is off. (The in-operation lamp is also off.)
※Be careful that you can not change the set temperature while the heat switch is on and the in-operation lamp is also on.

- ② Push the temperature setting button  (upward) or  (downward) once and the current set temperature is indicated for about 2 seconds.
※The temperature indicator goes on and off when the set temperature is indicated.

- ③ To raise the set temperature, push  button while the set temperature is indicated. Push the button once and the temperature goes up one °C each time. Push and hold  button and the temperature goes up continually. When the temperature indicator is coming closer to the set temperature, give the button a one-push a couple of times until obtaining the temperature required.
※When the temperature indicator surpasses the required set temperature, push the  button to lower the set temperature.
※ When the temperature setting button is left untouched for about 2 seconds, the temperature indicator automatically goes back to the current temperature and the set temperature is fixed.

- ④ To lower the set temperature, follow the same directions as above using the appropriate temperature setting buttons.



7-3) Confirmation of Set Temperature

To indicate the set temperature, push either  button or  button lightly once, and the set temperature is indicated for about 2 seconds.

※You can see the set temperature, but can not change it while the heat switch is on.

7. How to Operate *PolySprint*[™] Heat Press- continued

7-4) Operation (Heating)

- To start operation, push and hold the  switch. The in-operation lamp lights up and controlled power is supplied to the heater. Heating begins.
- ※To avoid malfunction, you always need to push and hold the  switch for about two seconds when turning it on or off.



When handling the press while it is in use, always wear anti-heat gloves to prevent burns.

※As the controlled power is supplied to the heater, the heater output power indicator on the temperature indication display goes on and off (the heater output power indicator is on when the controlled power is supplied and is off when the controlled power is ready to supply.)



An operator should not leave a press unattended while it is in use. To help prevent burns, pay attention to others who may carelessly touch the press.

- To stop operation, push and hold the  switch once more. Heating control of the heater comes to a stop and the in-operation lamp lights off.



The press is still at a high temperature after operation. When handling the press, always wear anti-heat gloves to prevent burns.



The press is still at a high temperature after operation. It takes about two hours for the press to cool down to room temperature. An operator should pay attention to others who might carelessly touch the press.

8. How to Make Belts Endless

8-1) Required Tool

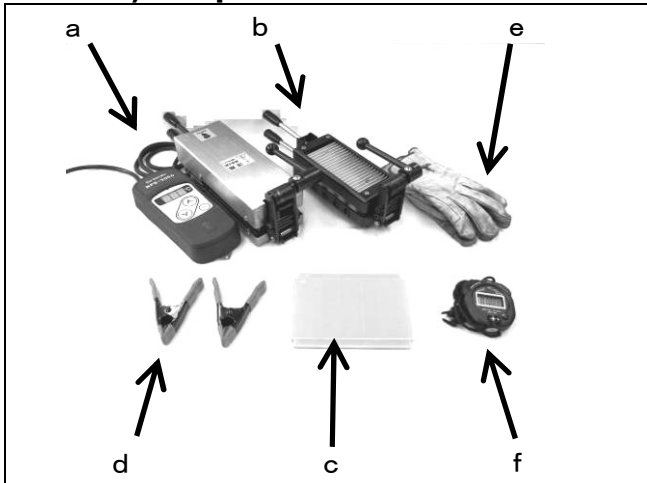

- a. Heat Press (NPS-0310H1/H2)
 - b. Cooling Press (NPS-0310C)
 - c. Pre-setter
 - ※Pre-setter is required for each belt width.
 - d. Pre-setter Clamp
 - e. Anti-heat Gloves (burn-preventive protection kits)
- WARNING** The press body reaches a high temperature. Always use anti-heat gloves to prevent burns.
- f. Stopwatch or timer

8-2) Work Procedures

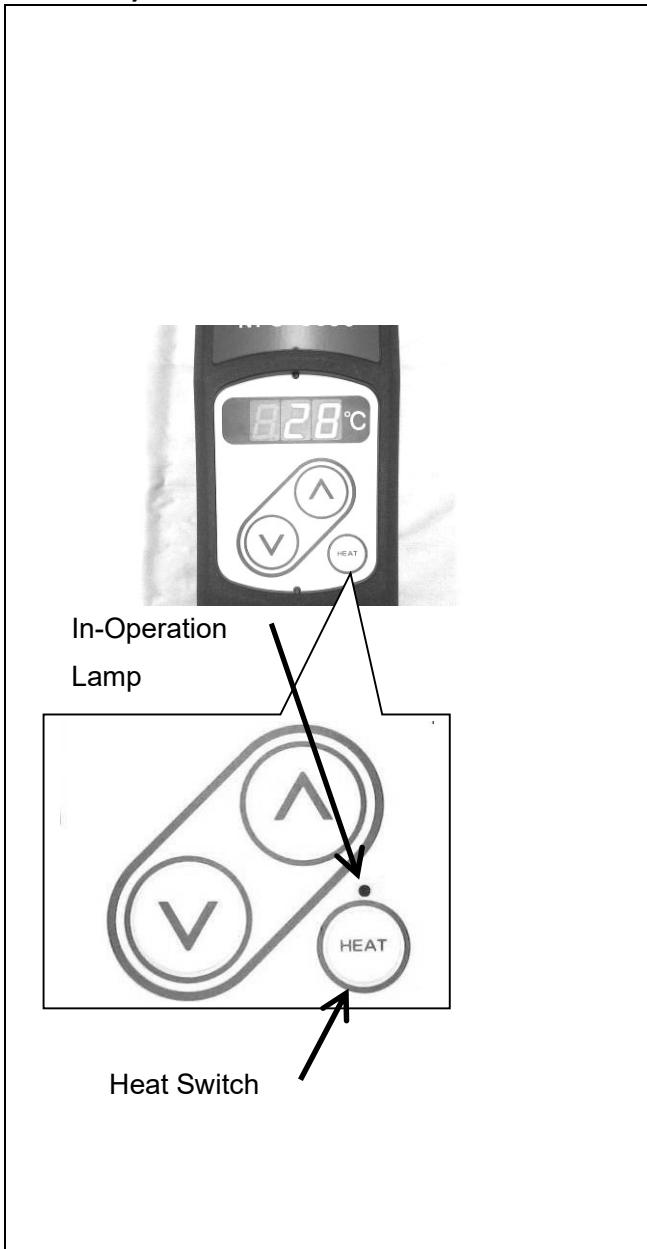

- ① Pre-heating
 - Connect the main plug to the socket outlet.

WARNING Be sure to connect an earth line to prevent electric shock.

 - The current temperature is indicated on the temperature indication display.
 - Confirm the set temperature. Set the temperature to match the belt type and belt width.
 - ※For the set temperature by belt type and belt width, refer to the Endless Conditions Table.
 - ※For changing of the set temperature, refer to the procedure 7-2) on page 11.
 - Push and hold the Heat Switch for about two seconds to start heating. The press will be heated up to the set temperature.
 - ※ The in-operation lamp above the Heat Switch is on while the press is in use.

WARNING Be sure to wear anti-heat gloves when handling the press while it is in use.

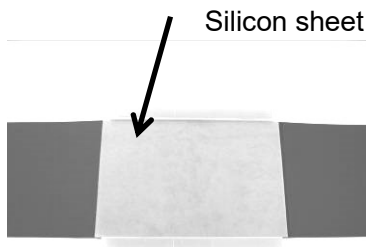
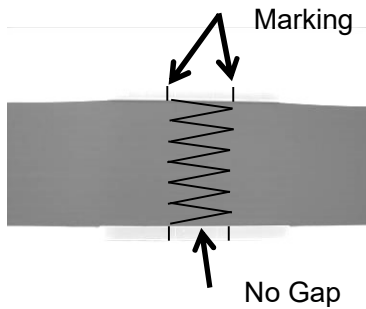

② Setting Belt on Pre-setter

- Set both edges of the belt on the bottom plate.
 - ※Match both edges so that there is no gap in the joint sections.
 - ※Set the joint section within the marking lines on the Pre-setter.
 - ※Confirm that the belt is not twisted.
 - ※Refer to the Endless Conditions Table for correct placement of each belt in the Pre-setter.



Always use a pre-setter supplied by Nitta.

Use of any other product possibly results in an improper endless joint and may cause fire.

- Set the silicon sheet on the belt.
 - ※The silicon sheet can be used on each surface.
 - ※Remove any dust or foreign object on the silicon sheet.
 - ※If there is any deterioration, damage or destruction to the silicon sheet, replace it with a new one.
- Place the top plate over the silicon sheet.
- Fix the pre-setters with clamps.
 - ※Fix pre-setter clamps the edges of the pre-setter. Otherwise, the pre-setter will not fit into the press correctly.

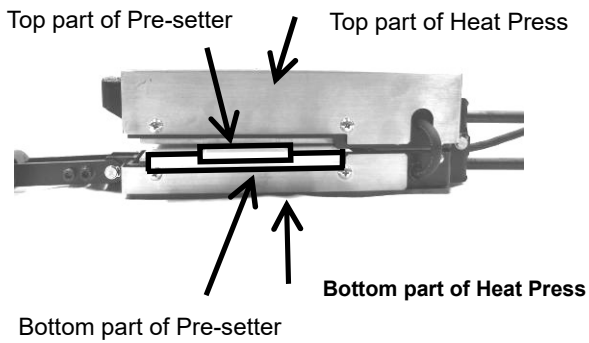

Centre the pre-setter in the heat press.

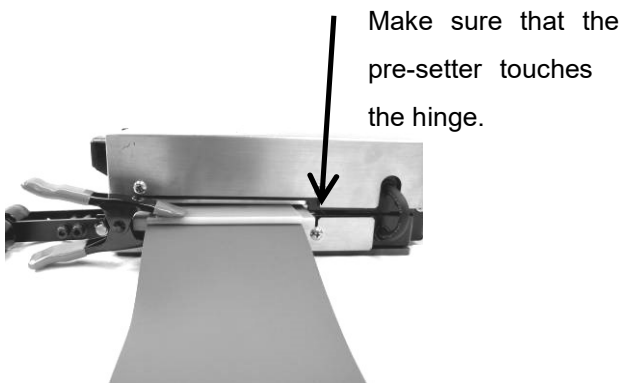
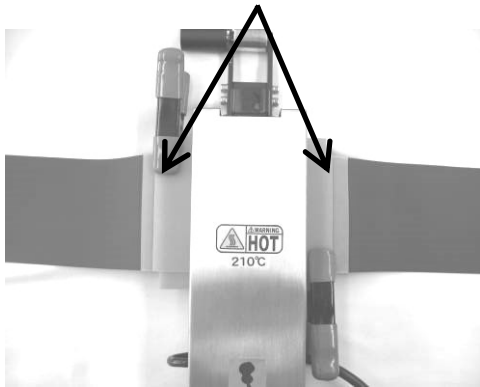

③ Heating Belt



Be sure to wear anti-heat gloves in the following procedures.

- Check the current temperature of the press to see if it has been heated up to the set temperature.
- Grasp the press handles and open the mouth of the press.
- Hold the pre-setter clamps and set the pre-setter in the heat press.

✘Be sure the pre-setter is set as shown left.

Do not set it upside down or it may cause an unsuccessful joint. (Place the bottom plate of the pre-setter on the bottom part of the heat press, and the top plate of the pre-setter under the top part of the heat press.)

✘Position the pre-setter so that it is centered in the press.

✘Insert the pre-setter all the way into the press until it touches the hinge.

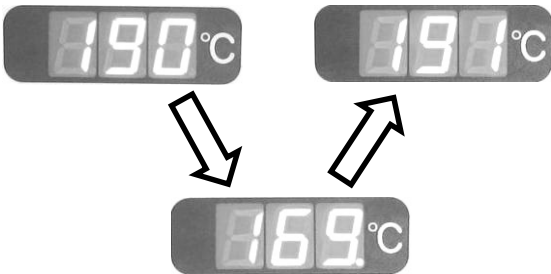
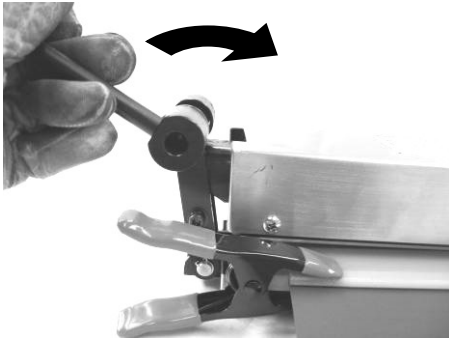

- The cam is hitch to the frame. And the clamp lever is turn to the main body side.

※Turn until the clamp lever becomes parallel to the main body.

※It is normal that the current temperature drops by 20~30°C right after the pre-setter is inserted. The pre-setter cools the press, but it will be heated up to the set temperature.

※※Monitor the heating time by a stopwatch or timer. Heat the press for the specified time for the belt type and belt width. For details on the heating time, refer to the attached Endless Conditions Table.

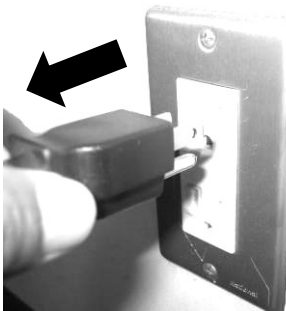
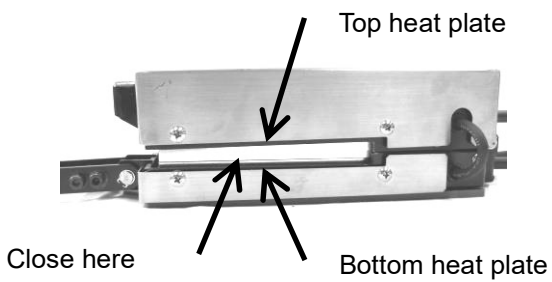
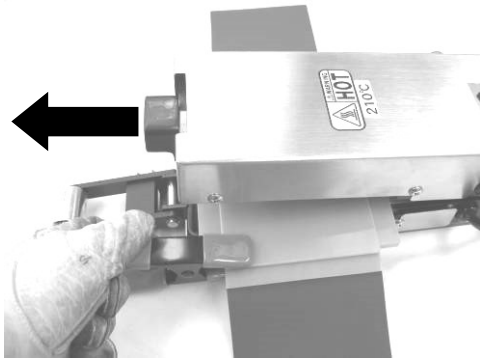

- When press is done, take the pre-setter out of the heat press and insert it in the cooling press.



The pre-setter is quite hot after press. Always use anti-heat gloves to prevent burns.

※When doing continuous press, close the heat press tight and leave it for 5 seconds or longer after taking out the pre-setter. When press is done, it creates a gap in temperature between the top and bottom plates. To maintain the temperature of both plates as same as possible, it is necessary to close the heat press before next press. This stably enables successful joints.



Immediately disconnect the main plug from the socket outlet after the use of the press. Pay attention that others do not touch the press before it is cooled down to a safe temperature.

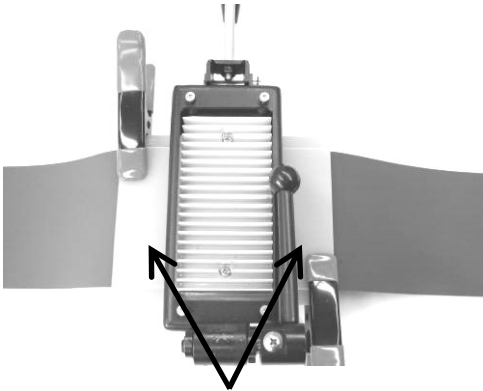
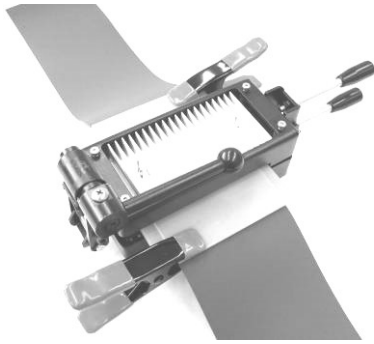

Center the pre-setter in the cooling press.

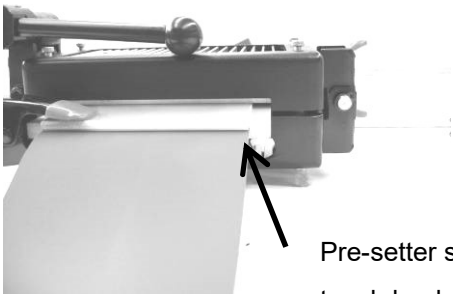

Pre-setter should touch back of press.



④ Cooling the Belt

- Remove the pre-setter from the heat press by grasping the pre-setter clamps and move the pre-setter to the cooling press.
- Turn until the clamp lever becomes parallel to the main body.

※Relax the handles, which apply pressure, and cool for specified time. For cooling time, refer to the Endless Conditions Table.

※Like the heat press, position the pre-setter centered in the cooling press and insert the pre-setter all the way in until it touches the back of the press.

⑤ Taking out the Belt

- After cooling for the specified time, hold the clamps and remove the pre-setter from the cooling press.

※The pre-setter is still at a high temperature after cooling time. Be careful when handling the pre-setter.

- Remove the belt from the pre-setter in this order: clamps, pre-setter top plate, silicon sheet, and belt.

※The belt may be used once it reaches room temperature.



WARNING Continual use of the cooling press may cause the press body to sustain a high temperature. This may result in burns and tends to deteriorate the cooling efficiency. Use the cooling press after it cools down to room temperature.

9. Troubleshooting

Problem	Cause		Solution
There is no indication on the temperature indication display.	The main plug is disconnected.		Connect the main plug.
	Is the power supplied to the socket outlet?	YES	The heat controller may be out of order or the power cable may be broken. ※Contact Nitta for more information.
		NO	Supply the power to the socket outlet.
The temperature indication display is indicating "0" and it can not be changed by pushing the temperature setting button.	Did the problem occur within a few seconds after the main plug is connected to the socket outlet?	YES	The press is starting to work. Wait for a while.
		NO	The heat controller may be out of order. ※Contact Nitta for more information.
The temperature indication display indicates E-1	The temperature sensor is out of order.		The temperature sensor must be repaired. ※Contact Nitta for more information.
The temperature indication display indicates E-2 and the press does not work.	The heater of the press is overheated. (The temperature is over 240 °C and controlled power is shut off with the protection circuit.)		Disconnect the main plug. Leave the heat press as is for a short while until it is cooled down. Then start over. If E-2 is indicated repeatedly, contact Nitta for more information.
The temperature can not be set.	The heat switch is on. (The in-operation lamp is on.)		Turn the heat switch off and change the set temperature.
	Push the temperature setting button. Is the temperature indication display showing the set temperature?	YES	Push the button once and the temperature raises 1°C each time. Push and hold, and the temperature can be changed continually. ※For more details, refer to the procedure 7-2 on page 11.
		NO	The heat controller may be out of order. ※Contact Nitta for more information.
The press can not be heated up to the set temperature.	Is the power source applied correct?	YES	The heat controller may be out of order or the wire in the heater may be broken. ※Contact Nitta for more information.
		NO	Apply appropriate power.
The heat switch is on, but the press isn't heated up or continues to cool down.	The heater is disconnected, the fuse blew out or the temperature controller is broken.		The heat press must be repaired. ※Contact Nitta for more information.

10. Inspection

Inspection items	date/staff	date/staff	date/staff	date/staff	date/staff
The power cable is free of damage or destruction.					
The control cable is free of damage or destruction.					
The heat controller is free of damage or destruction.					
All screws of the heat controller are tightened.					
Main plug is free of damage or destruction.					
The press body is free of damage or destruction.					
All screws of the press body are tightened.					
The heating plate is free of foreign object or any resin.					
The pre-setter is free of damage or destruction.					
The pre-setter is free of foreign object or any resin.					

Make a copy of this page and use it for a prior-to-use inspection

11. Warranty and after-sales service

1. Warranty period

The warranty period is for one full year after the delivery of the order at your appointed place.

2. Warranty coverage

1) Should the product malfunction due to causes for which our company is responsible during the abovementioned warranty period, our company will provide a replacement product or repair the product free of charge. However, even within the warranty period the following cases shall not be covered by the warranty. Please note that even if our company provides a replacement product or repairs the product, the warranty period will be calculated from the initial date on which the product was delivered.

- ① Malfunction arising from any inappropriate conditions, environment, handling and usage which are not described in the Operation Manual and the Endless Splicing Procedure.
- ② Malfunction due to a cause arising from something other than the product, such as your own device.
- ③ Malfunction arising from any remodeling or repairing by other than our own company.
- ④ Malfunction arising from any reasons unpredictable due to our level of chemistry and technology before shipment.
- ⑤ Malfunction arising from fire, earthquake, flood, other disasters, voltage error, or other external factors for which our company bears no responsibility.

2) The warranty coverage is limited to what is stated in 1) above, and the warranty does not cover secondary damages (equipment damage, opportunity loss, profit loss) and any other damage incurred by the user as a result of a malfunction of the product.

3) After the warranty period, if after examination the product is repairable, our company will repair it upon request.

Memo

NITTA CORPORATION

4-4-26 Sakuragawa Naniwa-ku, Osaka 556-0022 Japan
Phone:+81-6-6563-1225 Fax:+81-6-6563-1242
<https://www.nitta.co.jp/en>



NITTA CORPORATION OF AMERICA

7605 Nitta Drive, Suwanee, GA 30024, U.S.A.
Phone:+1-770-497-0212 Fax:+1-770-623-1398
<http://www.nitta.com>

NITTA CORPORATION OF HOLLAND B.V.

Berenkoog 25, 1822 B.H, Alkmaar, The Netherlands
Phone:+31-72-5622234 Fax:+31-72-5613238
<http://www.nitta.nl>

NITTA (SHANGHAI) MANAGEMENT CO., LTD

Room 2705, Shenggao International Building, No.137 Xianxia Road, Shanghai 200051 CHINA
Phone:+86-21-6229-6000 Fax:+86-21-6229-9606
<http://www.nitta-cn.com>

NITTA CORPORATION INDIA PVT. LTD.

Gat No 191, 192, and 193, Plot No B, Village Vadhu Khurd, Taluka Haveli Dist Pune-412216, INDIA
Phone:+91-20-6731-3400 Fax:+91-20-6731-3401
<http://www.nitta.co.in>

KOREA NITTA MOORE CORP.

53, Suchul-daero 5-gil, Gumi-si, Gyeongbuk-do, 39266, KOREA
Phone:+82-54-461-5575 Fax:+82-54-461-5350
<http://www.nitta.co.kr/>

TAIWAN NITTA FILTER CO.LTD.

Headquarters: Chia Hsin Building 10FL Room No. 1005, 96 Chung Shan North Road Section 2, Taipei, Taiwan
Phone:+886-2-2581-6296 Fax:+886-3-469-0260
<http://www.nitta.com.tw>

NITTA INDUSTRIES EUROPE GmbH

Heerdter Lohweg 35, 40549 Dusseldorf, Germany
Phone:49-211-537535-0 Fax:+49-211-537535-35
<http://www.nitta.de>

NITTA CORPORATION OF SINGAPORE PTE LTD.

120 Lower Delta Road, #05-07/08
Cendex Centre, Singapore 169208
Phone:+65-6438-8738 Fax:+65-6438-8793
<http://www.nitta.com.sg>
<Liaison Office> Indonesia, Vietnam

NITTA CORPORATION (THAILAND) LIMITED

7/472 Moo 6, Tambol Mabyangporn, Amphur Pluakdaeng, Rayong Province 21140, THAILAND
Phone:+66-38-018-301 Fax:+66-38-018-304
<http://www.nittathai.com>

NITTA BRASIL

Rua Francisco Mommenshon, 50B, Galpão 02 Laranjeiras, Caieiras, São Paulo, Brazil
Phone/Fax:+55-11-4441-2922
<http://www.nitta.com.br>

CONNECT CONVEYOR BELTING INC.

405 Industrial Drive Unit 3-8, Milton, Ontario Canada L9T 5B1
Phone:+1-905-878-5552 FAX:+1-905-878-0344
<http://www.connectbelting.com>

The specification is subject to change for improvement without notice.

Oct, 2020 Rev12 NPS0310H-E